

PENDENT

INSTALLATION GUIDE

This guide is presented in good faith to assist in the installation of Pendants. It is not intended as an all-encompassing guide and, a professional qualified installer is recommended for optimum results.

Woven Image accepts no responsibility for installation actions taken or not taken. Please refer to Woven Image Pty Ltd. Terms of Trade.

This installation guide contains only recommendations; if you have any questions about installation techniques please contact your distributor or Woven Image sales representative.

Please note:

- Please check that all Pendant components are the correct colour, shape and same batch number (if requested).
- No claims will be accepted after the Pendants have been installed.
- Stock may vary due to the fibre mix and lay up which is an inherent feature of Pendant.

SPECIFICATION

- Non-woven PET (60% post-consumer recycled)
 - ABS plastic bracket
 - Anodised aluminium sleeve (3 colours)
 - Stainless steel cable, ceiling mount & wire spacer
 - 2000mm cable length
 - EchoPanel® Pendant 12mm, Pendant Dot, Pendant Splay, Pendant Summit, or Pendant Tandem
 - Box Dimensions: 2866mm x 1375mm x 64mm
-

BOX CONTENTS

- 1 x Cut EchoPanel®
 - 4 x Brackets
 - 12 x Sleeves (4 of each colour)
 - 2 x Cables
 - 2 x Ceiling mounts
 - 2 x Wire spacers
-

PENDENT

INSTALLATION GUIDE

COMPONENTS

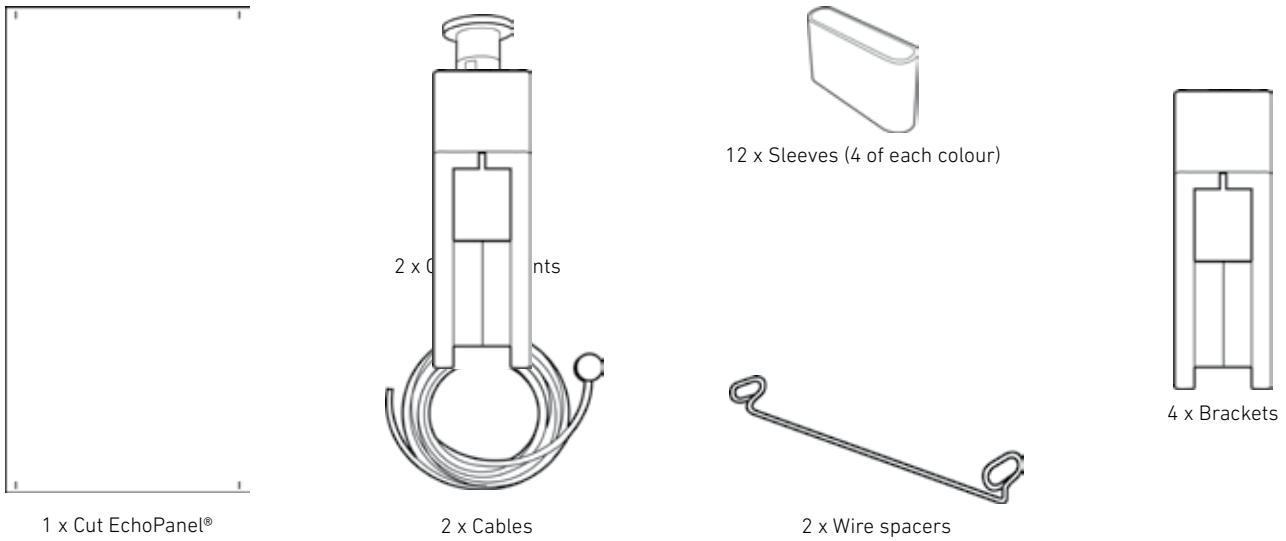

INSTALLATION

Step 1

- Remove all components from the box and check you have received all pieces using the above component list.
- Push out the cutout pieces. There are four rectangular cutouts in each corner, push these out first.
- If using a patterned Pendent (Dot, Splay, Summit, or Tandem) continue to push out all cutouts to reveal the pattern. Once removed, set the EchoPanel® aside.

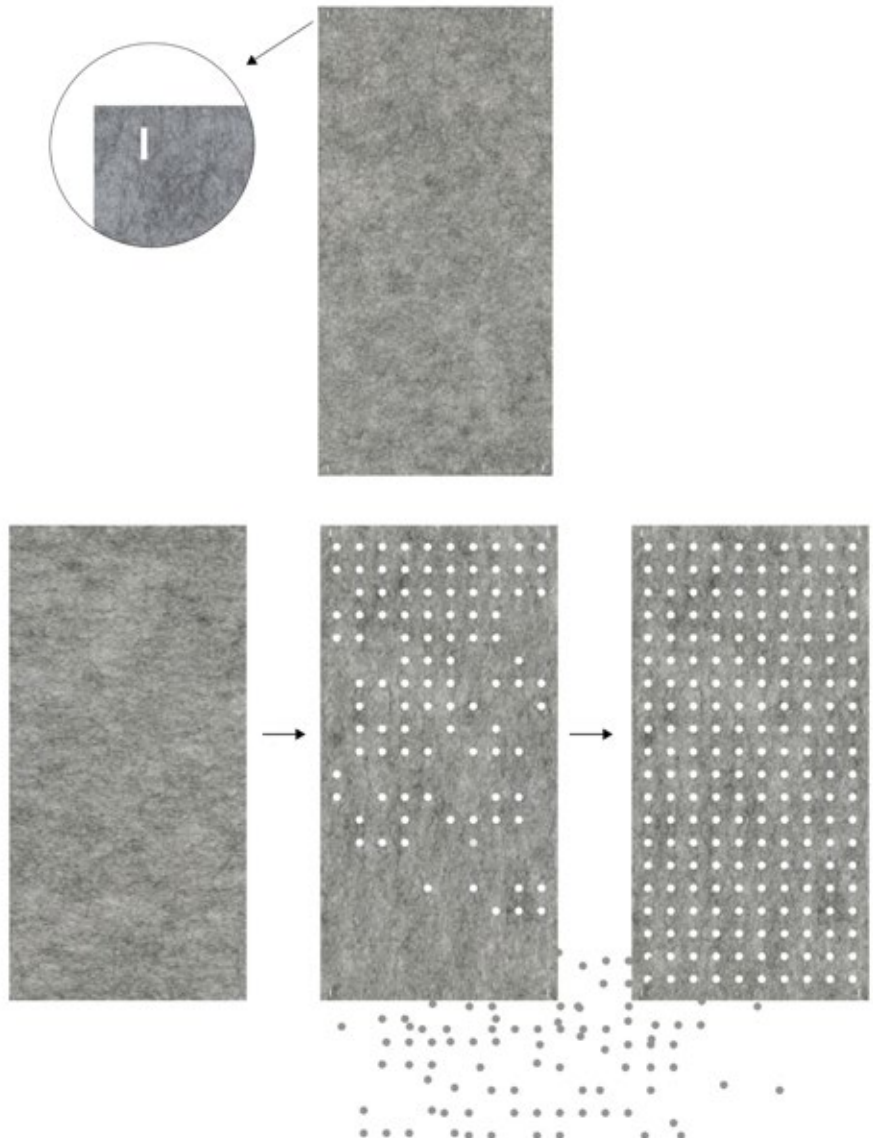

PENDENT

INSTALLATION GUIDE

Step 2

- Take one of the bracket components and pull apart into two pieces (pins are removable).

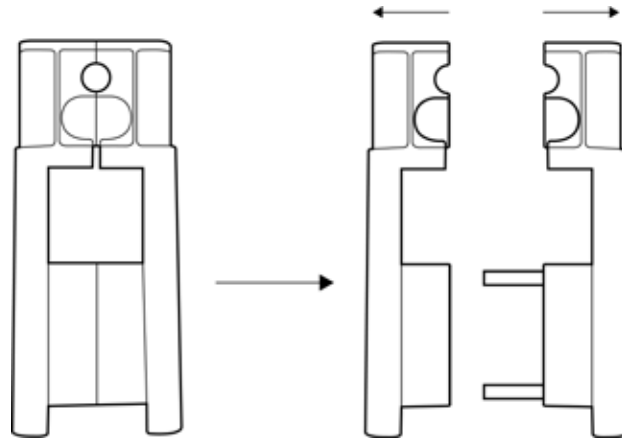

Step 3

- Align the two bracket pieces over one of the rectangular cutouts located in each corner of the panel.
- Thread the sleeve over the cable and secure the cable's circular barrel into the circular cavity in the bracket.



Step 4

- Clip the two pieces of the bracket back together and slide the sleeve down.
- Repeat Steps 2 - 4 for the remaining three brackets.
- The cable does not need to be added when assembling the two bottom brackets.

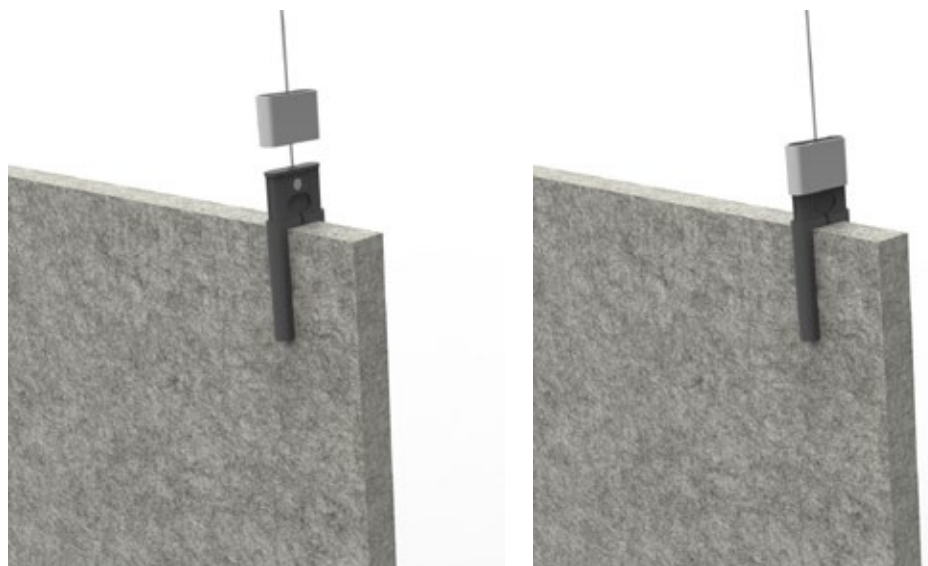

PENDENT

INSTALLATION GUIDE

Step 5

- Set aside the EchoPanel® while you install the ceiling mounts.

To install the mounts:

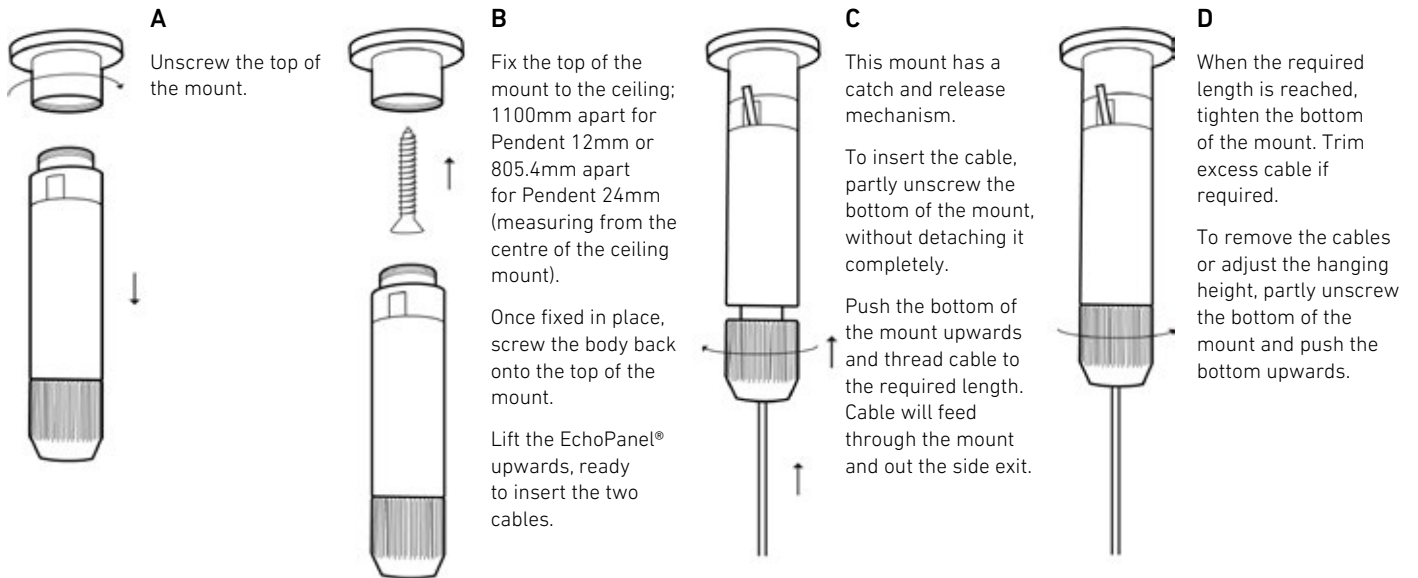

Joining panels together:

- To join panels together using the wire spacer, partially lift the sleeve and position the end of the wire spacer in the recess on the side of the bracket.
- Once the wire spacer is in position, slide the sleeve down to capture the wire. Repeat this on the other brackets to join.

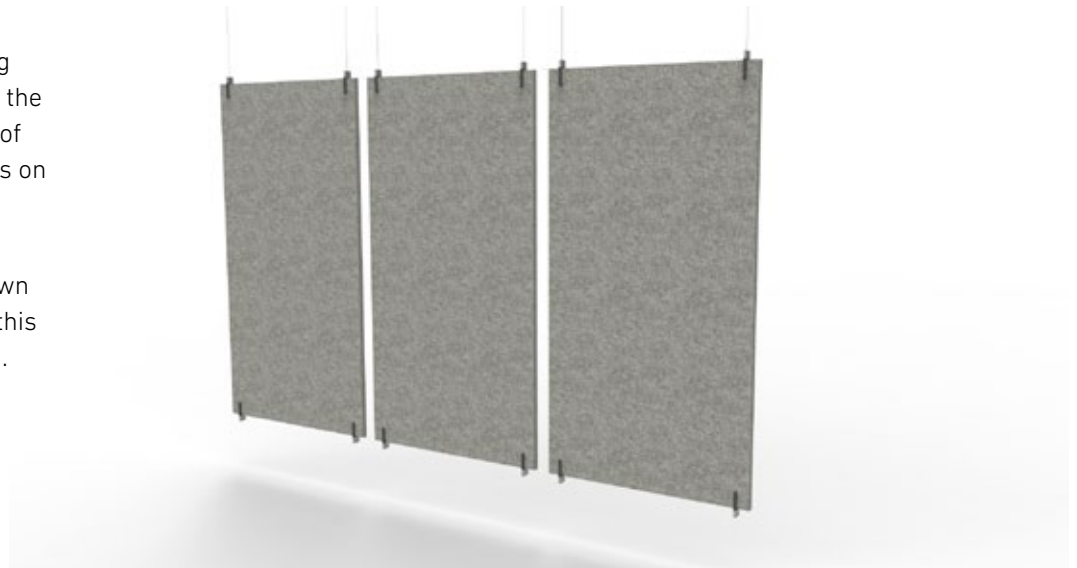

PENDENT

INSTALLATION GUIDE

SUGGESTED CONFIGURATIONS

Pendent Dot

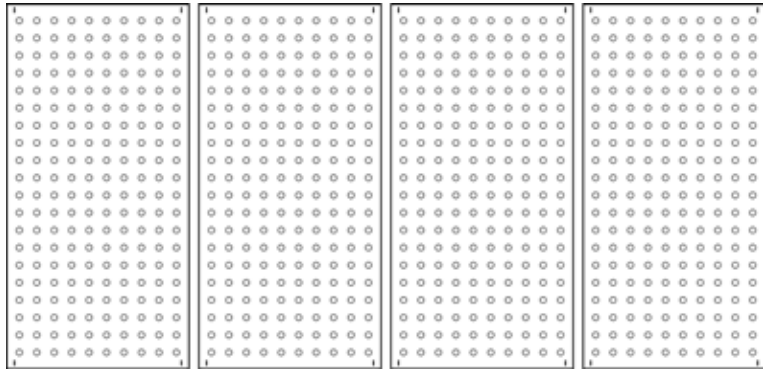

Pendent Splay

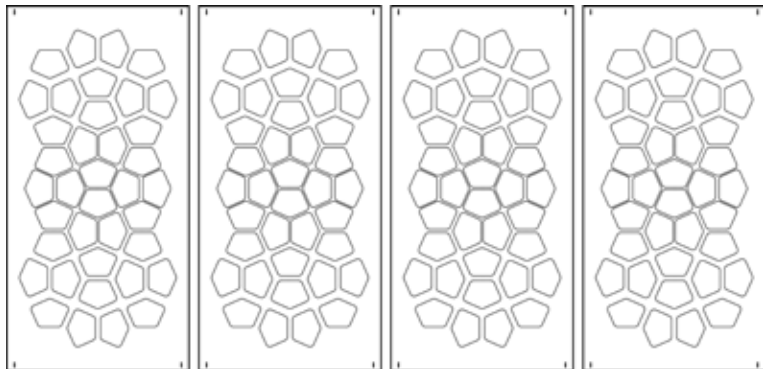

Pendent Summit

Configuration 1

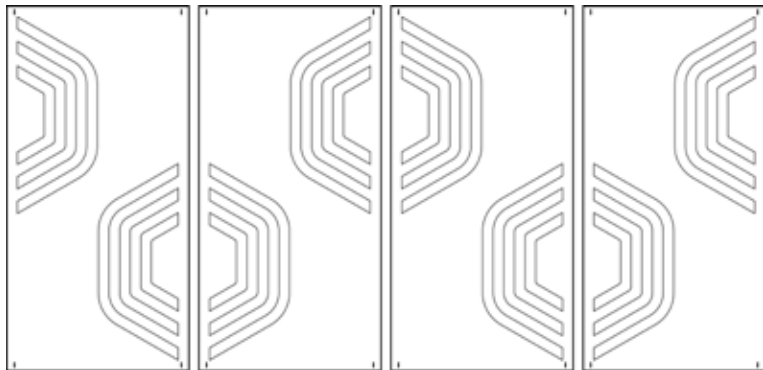

Configuration 2

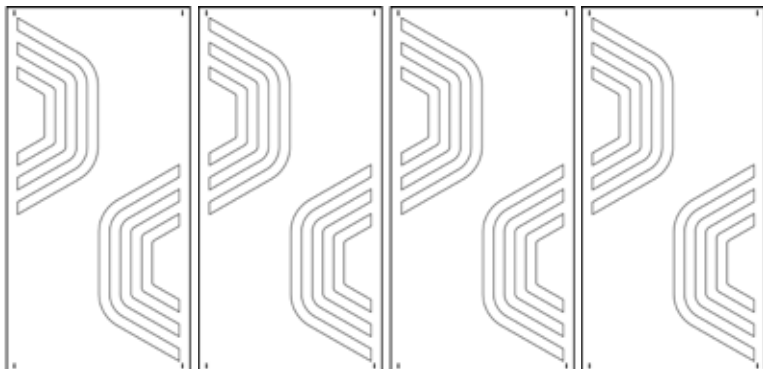

PENDENT

INSTALLATION GUIDE

Pendent Tandem

Configuration 1

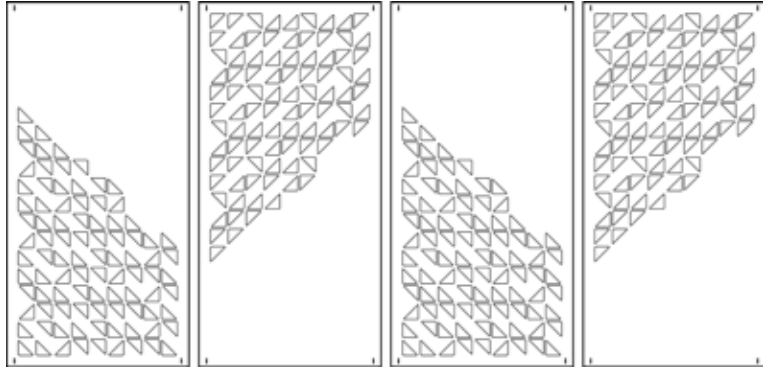

Configuration 2

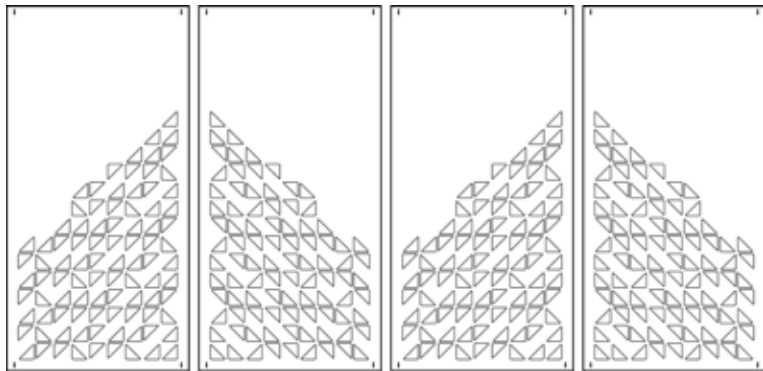

PENDENT WIRE SPACER DETAIL

