

## Array 24mm

**Designer:** Woven Image

**Application(s):** Ceilings

### Composition & Pattern

**Composition** EchoPanel Baffles 100% PET (60% post-consumer recycled)

**Hardware Composition** 100% Powder coated Aluminum Alloy 6060

**Colours Available** 20

### Kit & Box Content

**Box Contents** Acoustic baffles plus hardware. Baffle quantities vary depending on design

### Dimensions & Weight

**Dimensions** Hardware and baffle dimensions will vary per design, see drawings on spec.

**Unit of Sale** Box

**Unit of Sale Net Weight (kg)** 20.46

## Performance

<b>Fire Test Result</b>	ISO 9705: Group 1, BS EN 13501.1: Classification B - s1, d0, ASTM E84 Unadhered: Class 1 or A
<b>Acoustic Performance Standard Test Method</b>	AS ISO 11654: 2002 (2016), AS ISO 354: 2006 (R2016), ASTM C423 - 17
<b>Noise Reduction Coefficient (NRC) Result</b>	Direct fix: 0.85
<b>Sound Absorption Average (SAA) Result</b>	Direct fix: 0.83
<b>Weighted Sound Absorption Coefficient (<math>\alpha_w</math>) Result</b>	Direct fix: 0.75(MH)
<b>Sound Absorption Class</b>	C (Direct fix)
<b>Equivalent Absorption Area (<math>A_{eq}</math>) in <math>m^2</math> Sabins</b>	Direct fix: 125Hz = 0.15m <sup>2</sup> , 250Hz = 0.44m <sup>2</sup> , 500Hz = 0.46m <sup>2</sup> , 1000Hz = 0.70m <sup>2</sup> , 2000Hz = 0.85m <sup>2</sup> , and 4000Hz = 0.83m <sup>2</sup>
<b>Additional Acoustic Information</b>	Baffles tested were 2400mm x 300mm x 24mm, at 300mm spacing/centres. MH = Mid to High Frequency
<b>Colour Fastness to Light Standard Test Method</b>	ISO 105 B02
<b>Colour Fastness Light Rating</b>	6 - 7
<b>Light Reflectance Standard Test Method</b>	ASTM E1477
<b>Light Reflectance Value</b>	Luminous Reflectance Factors (see table below for all colours): Dark (550 Onyx): 2.76, Mid (338 Jade): 20.52, Light (500 Off White): 80.44

## Sustainability

<b>VOC Emissions Results</b>	EchoPanel 24mm achieves ASTM D5116: TVOC Emissions Rate: <0.02mg/m <sup>2</sup> /hr (7 days), and CDPH Standard Method v1.2: TVOC Emissions Rate: <0.054mg/m <sup>3</sup> ; Formaldehyde Emissions Rate: <2µg/m <sup>3</sup>
------------------------------	--

## Sustainability Performance



### Sustainability Performance Details

EchoPanel achieves GreenTag Certification GreenRate: Level A & Health Rate Platinum, Red List Free, and has an International Living Future Institute Declare Label. Array Baffles meet the sound reducing ceiling treatment requirements to attract points under feature S04 of WELL™ Standard v2.

## Instructions

### Additional Information

See Woven Image EchoPanel Care & Cleaning Guide.  
See Woven Image Array Installation Guide.

Exact colour matching cannot be guaranteed between batches. Fibre mix and web variation are natural characteristics of this product.

# ARRAY ACOUSTIC CEILING SYSTEM (AACS)

## OVERVIEW



The Array Acoustic Ceiling System (AACS) is a fully scalable acoustic ceiling system that accommodates 12mm & 24mm EchoPanel® baffles. It features streamlined aluminium hardware that has been engineered for easy installation, and can be used in both ceiling or wall applications. Below hardware all sold separately.

## HARDWARE OVERVIEW

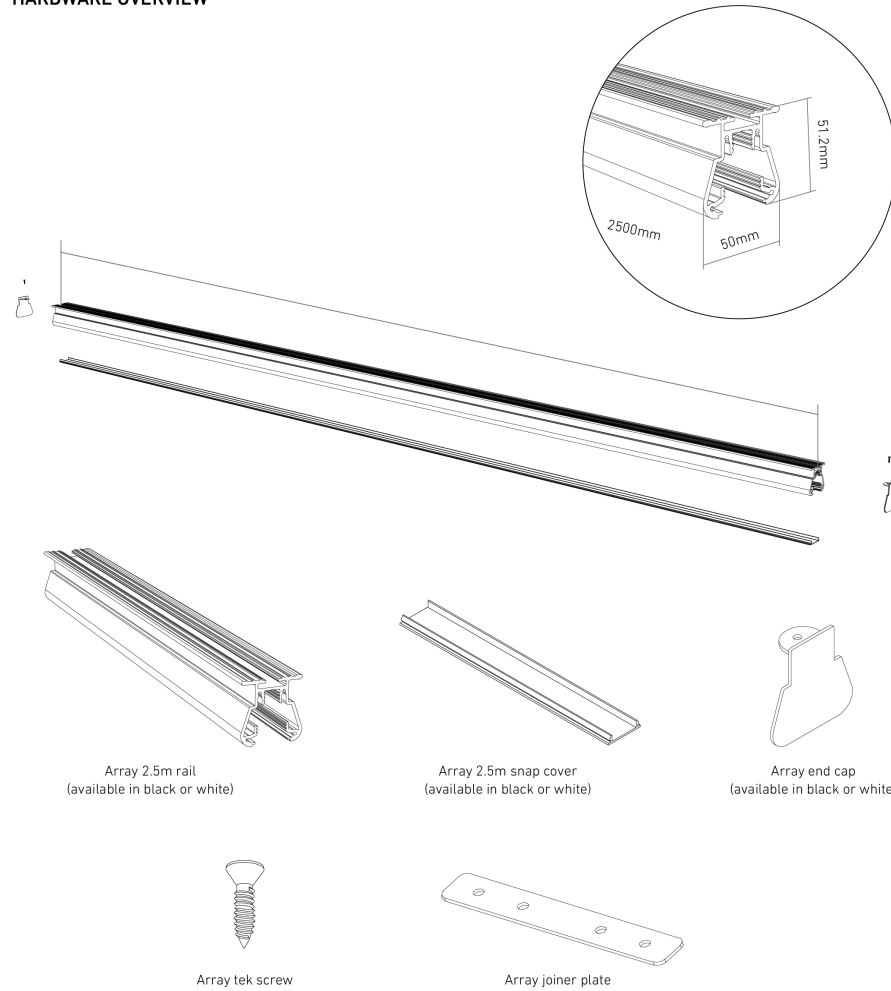

© Copyright Woven Image® Pty Ltd 2023, all rights reserved. This drawing may not be reproduced or transmitted in any form, or by any means in part or in whole, without the written permission of Woven Image® Pty Ltd

# BEAM 200

## ECHOPANEL® 24mm BAFFLE DESIGN



### STANDARD BAFFLE SIZE

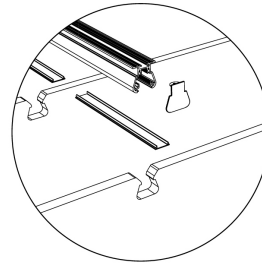
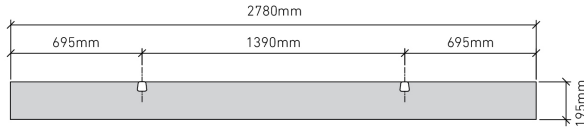

### CUSTOM LENGTHS ON REQUEST

(Maximum length 2780mm)

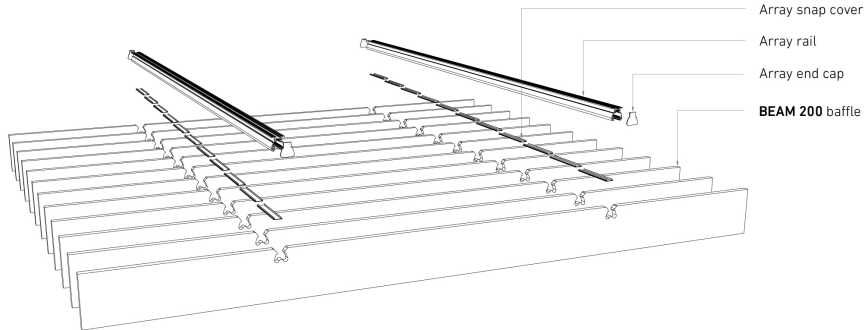
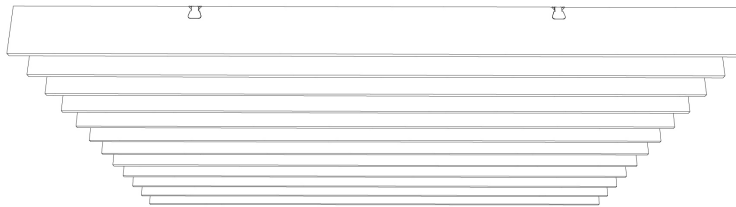
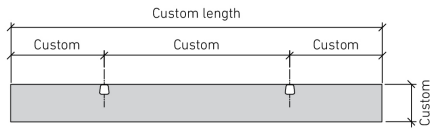

© Copyright Woven Image® Pty Ltd 2023, all rights reserved. This drawing may not be reproduced or transmitted in any form, or by any means in part or in whole, without the written permission of Woven Image® Pty Ltd

# BEAM 300

## ECHOPANEL® 24mm BAFFLE DESIGN



### STANDARD BAFFLE SIZE

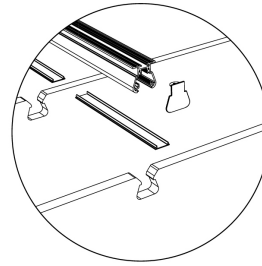
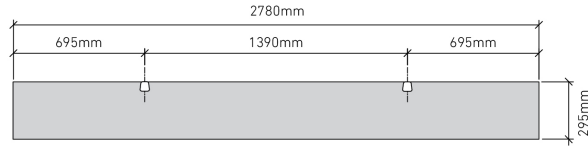

### CUSTOM LENGTHS ON REQUEST

(Maximum length 2780mm)

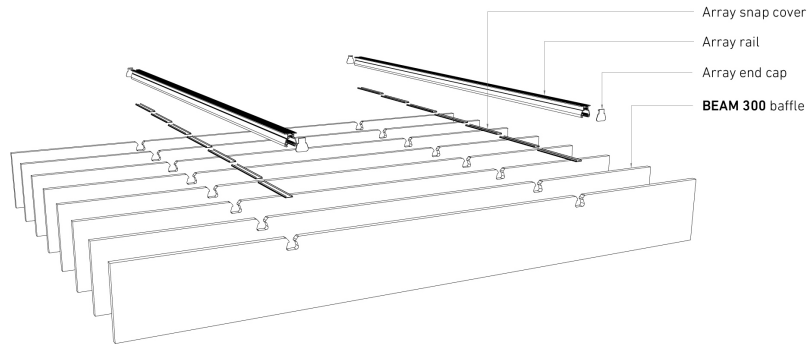
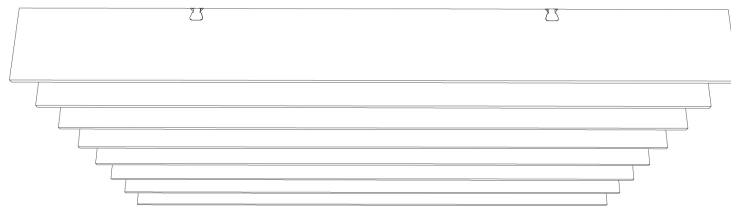
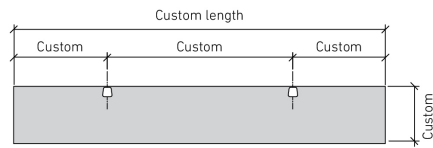

© Copyright Woven Image® Pty Ltd 2023, all rights reserved. This drawing may not be reproduced or transmitted in any form, or by any means in part or in whole, without the written permission of Woven Image® Pty Ltd

# CATHEDRAL

## ECHOPANEL® 24mm BAFFLE DESIGN



### STANDARD BAFFLE SIZE

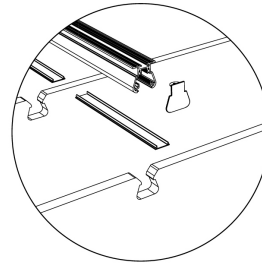
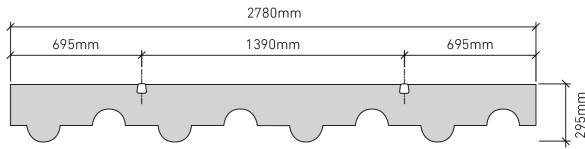

### CUSTOM LENGTHS ON REQUEST

(Maximum length 2780mm)

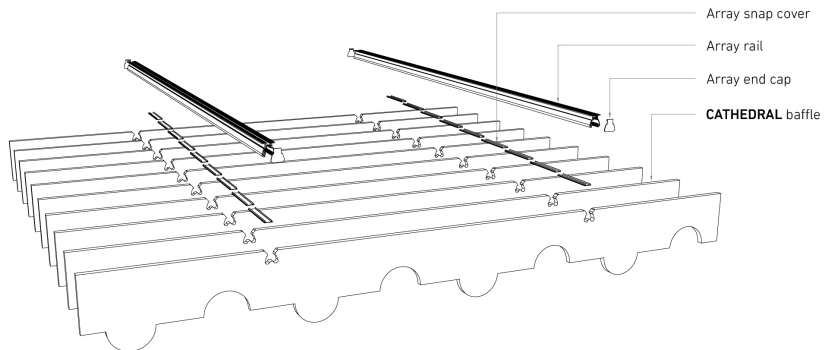
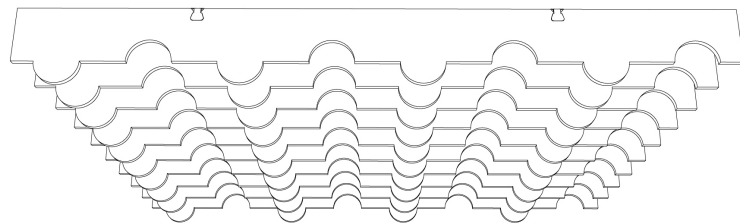
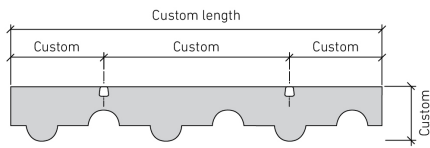

© Copyright Woven Image® Pty Ltd 2023, all rights reserved. This drawing may not be reproduced or transmitted in any form, or by any means in part or in whole, without the written permission of Woven Image® Pty Ltd

# FLOW

## ECHOPANEL® 24mm BAFFLE DESIGN



### STANDARD BAFFLE SIZE

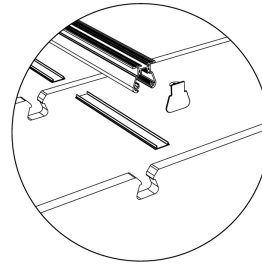
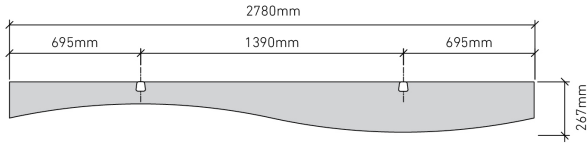

### CUSTOM LENGTHS ON REQUEST

(Maximum length 2780mm)

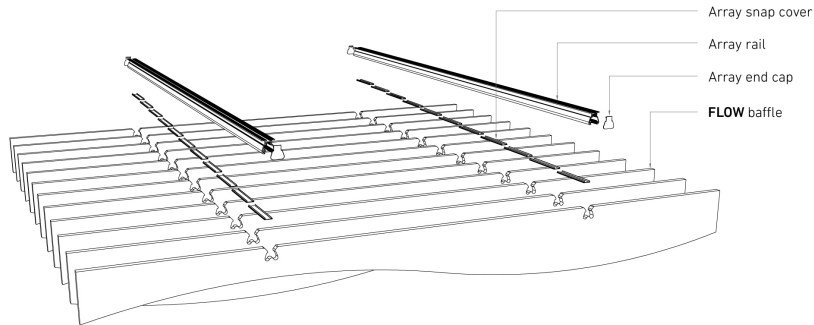
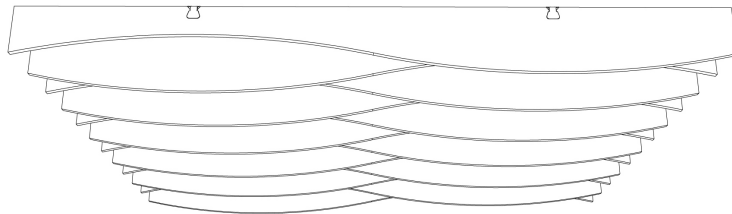
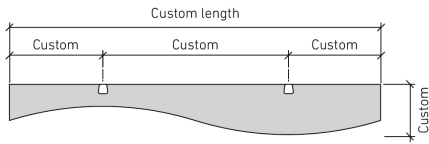

© Copyright Woven Image® Pty Ltd 2023, all rights reserved. This drawing may not be reproduced or transmitted in any form, or by any means in part or in whole, without the written permission of Woven Image® Pty Ltd

COLOUR CODE	COLOUR NAME	LUMINOUS REFLECTANCE FACTOR
550	ONYX	2.76
542	BLACK	5.36
330	IVY	7.30
269	WINE	7.34
365	NAVY	8.04
193	ROUGE	10.94
447	SLATE	11.88
484	CAYENNE	13.75
167	CINNAMON	14.44
349	VINEYARD	16.76
384	OLIVE	17.60
660	CORONET	19.07
295	MANDARIN	20.07
444	SMOKE	20.09
633	PACIFIC	20.38
338	JADE	20.52
402	PEBBLE	21.25
721	NUTMEG	26.62
442	GREY	30.40
580	SAGE	32.77
579	PISTACHIO	33.98
551	BLUE	35.67
124	OCHRE	36.09
274	ORCHID	38.14
487	BLUSH	40.06
495	DUSK	41.16
468	VANILLA	42.59
101	FROST	45.64
454	MUSHROOM	52.03
573	MINT	54.87
908	CREAM	60.13
106	BUTTER	69.31
381	LIME SPLICE	69.31
500	OFF WHITE	80.44

# TAPER

## ECHOPANEL® 24mm BAFFLE DESIGN



### STANDARD BAFFLE SIZE

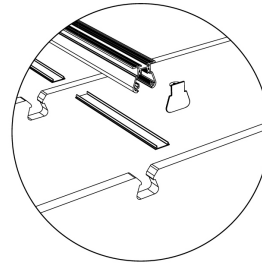
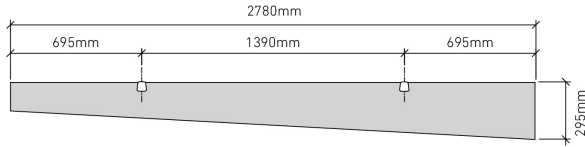

### CUSTOM LENGTHS ON REQUEST

(Maximum length 2780mm)

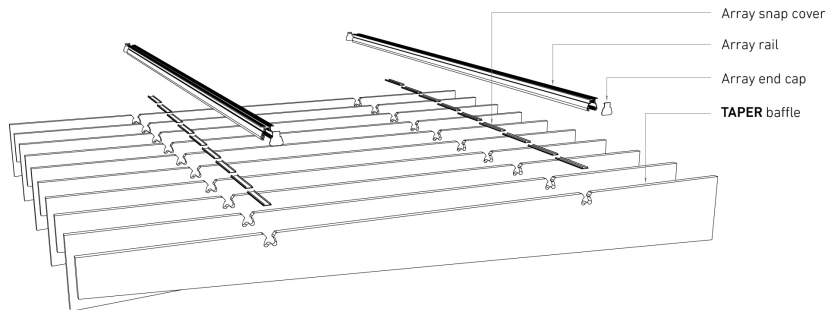
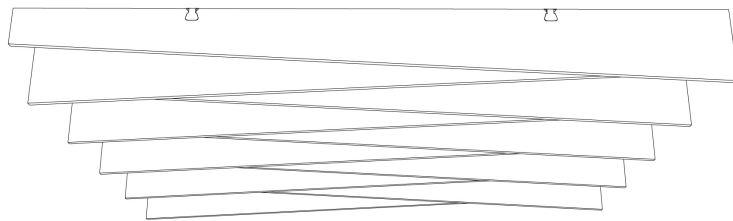
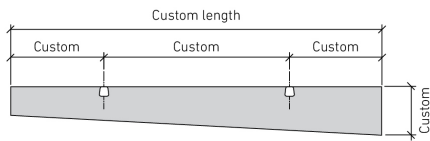

© Copyright Woven Image® Pty Ltd 2023, all rights reserved. This drawing may not be reproduced or transmitted in any form, or by any means in part or in whole, without the written permission of Woven Image® Pty Ltd

# TURRET

## ECHOPANEL® 24mm BAFFLE DESIGN



### STANDARD BAFFLE SIZE

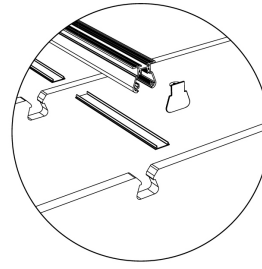
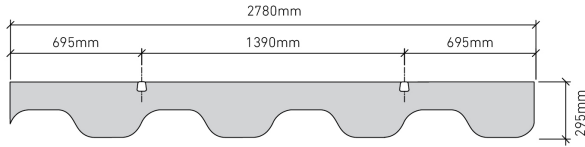

### CUSTOM LENGTHS ON REQUEST

(Maximum length 2780mm)

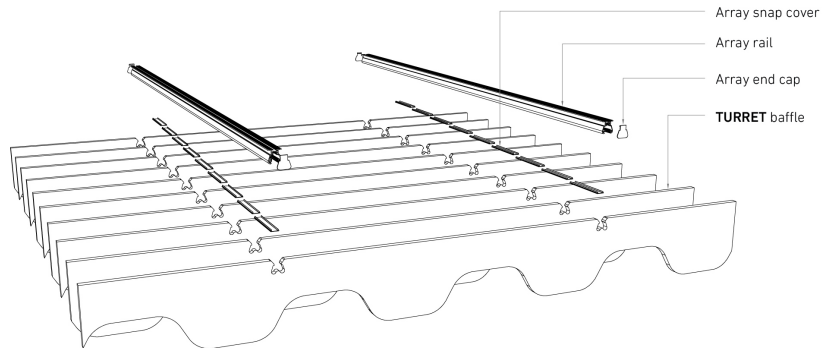
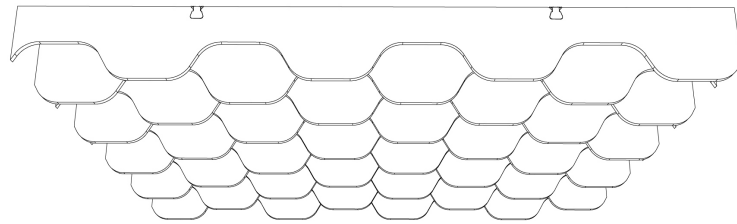
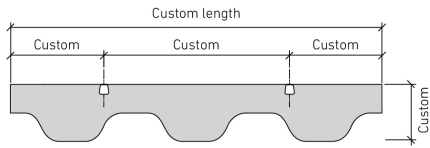

© Copyright Woven Image® Pty Ltd 2023, all rights reserved. This drawing may not be reproduced or transmitted in any form, or by any means in part or in whole, without the written permission of Woven Image® Pty Ltd

# VALLEY

## ECHOPANEL® 24mm Baffle Design



### STANDARD Baffle Size

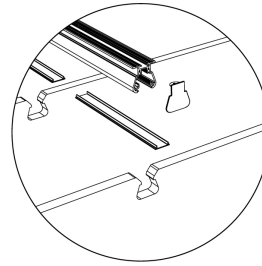
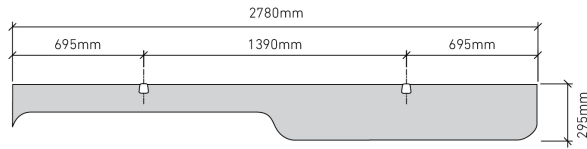

### CUSTOM LENGTHS ON REQUEST

(Maximum length 2780mm)

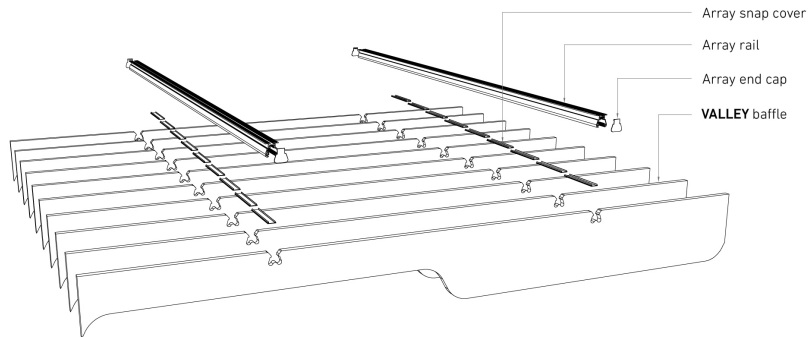
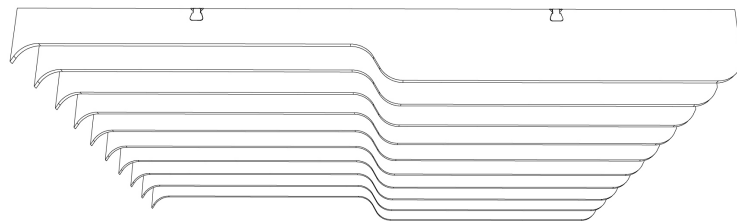
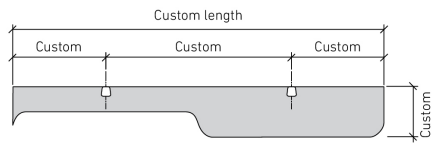

© Copyright Woven Image® Pty Ltd 2023, all rights reserved. This drawing may not be reproduced or transmitted in any form, or by any means in part or in whole, without the written permission of Woven Image® Pty Ltd

# VIADUCT

## ECHOPANEL® 24mm BAFFLE DESIGN



### STANDARD BAFFLE SIZE

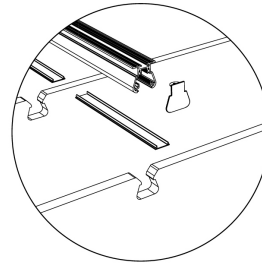
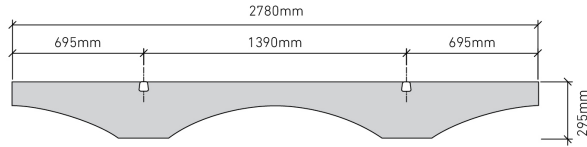

### CUSTOM LENGTHS ON REQUEST

(Maximum length 2780mm)

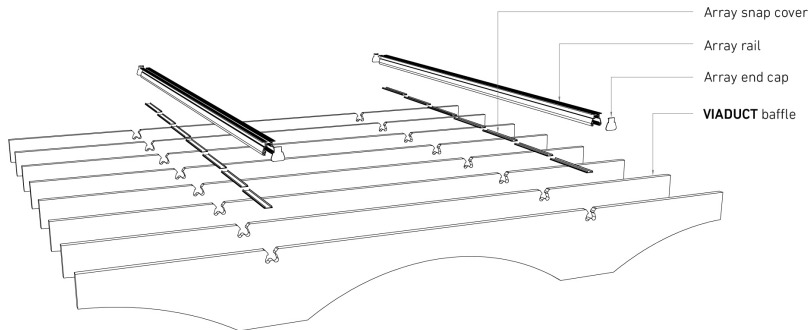
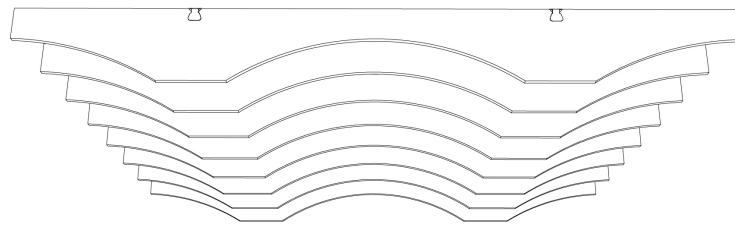
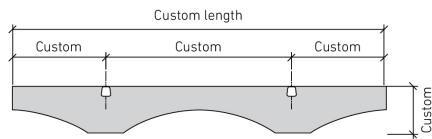

© Copyright Woven Image® Pty Ltd 2023, all rights reserved. This drawing may not be reproduced or transmitted in any form, or by any means in part or in whole, without the written permission of Woven Image® Pty Ltd

# WAVE

## ECHOPANEL® 24mm BAFFLE DESIGN



### STANDARD BAFFLE SIZE

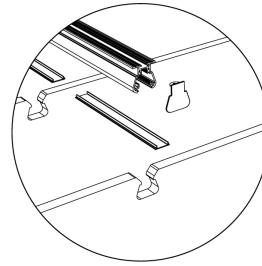
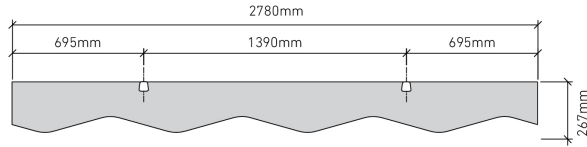

### CUSTOM LENGTHS ON REQUEST

(Maximum length 2780mm)

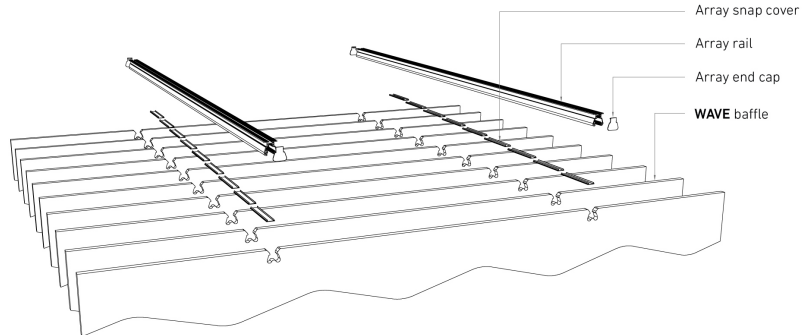
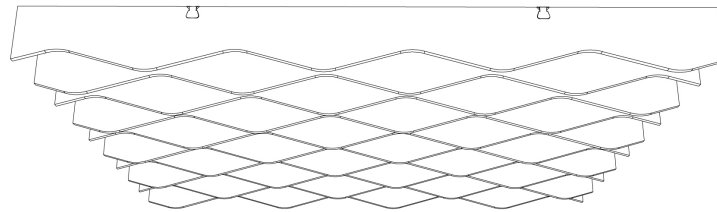
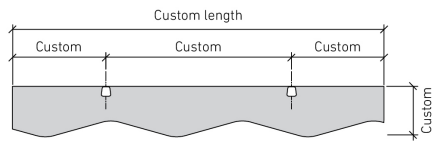

© Copyright Woven Image® Pty Ltd 2023, all rights reserved. This drawing may not be reproduced or transmitted in any form, or by any means in part or in whole, without the written permission of Woven Image® Pty Ltd

# WEDGE 200

## ECHOPANEL® 24mm BAFFLE DESIGN



### STANDARD BAFFLE SIZE

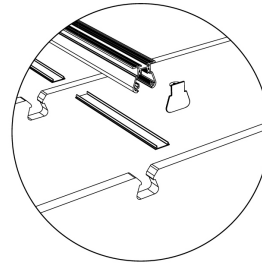
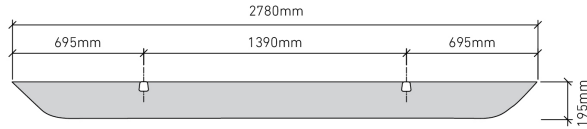

### CUSTOM LENGTHS ON REQUEST

(Maximum length 2780mm)

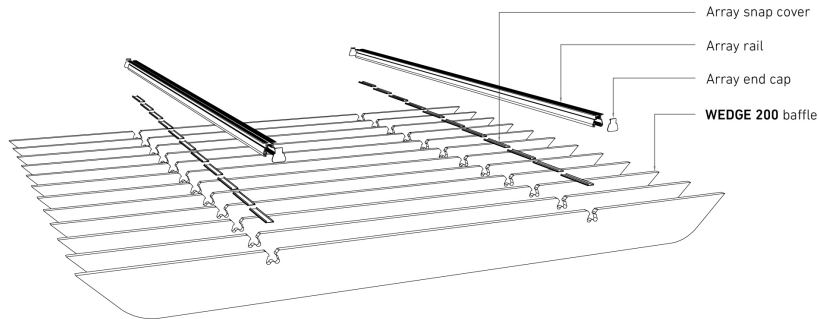
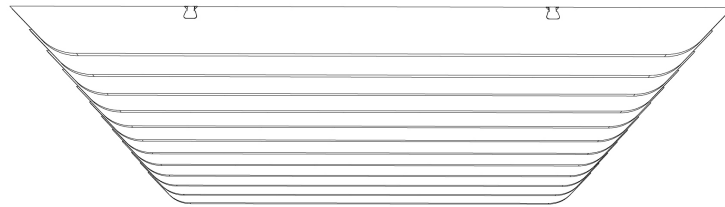
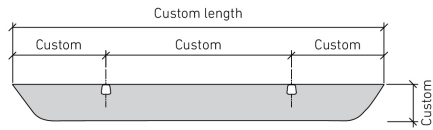

© Copyright Woven Image® Pty Ltd 2023, all rights reserved. This drawing may not be reproduced or transmitted in any form, or by any means in part or in whole, without the written permission of Woven Image® Pty Ltd

# WEDGE 300

## ECHOPANEL® 24mm BAFFLE DESIGN



### STANDARD BAFFLE SIZE

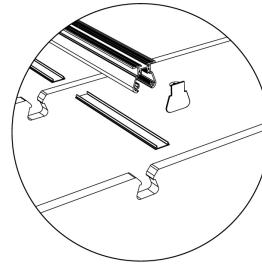
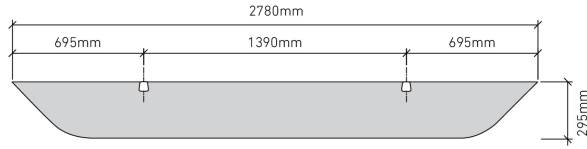

### CUSTOM LENGTHS ON REQUEST

(Maximum length 2780mm)

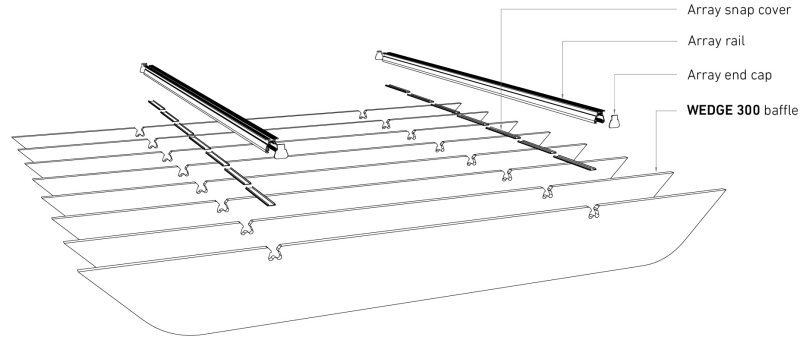
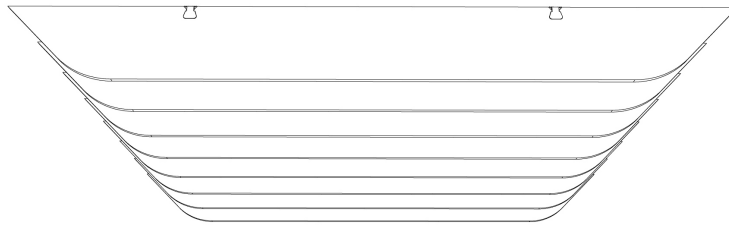
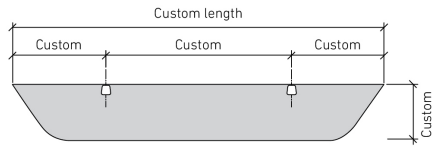

© Copyright Woven Image® Pty Ltd 2023, all rights reserved. This drawing may not be reproduced or transmitted in any form, or by any means in part or in whole, without the written permission of Woven Image® Pty Ltd