

Array 24mm

Designer: Woven Image

Application(s): Ceilings

Composition & Pattern

Composition EchoPanel Baffles 100% PET (60% post-consumer recycled)

Hardware Composition 100% Powder coated Aluminum Alloy 6060

Colours Available 20

Kit & Box Content

Box Contents Acoustic baffles plus hardware. Baffle quantities vary depending on design

Dimensions & Weight

Dimensions Hardware and baffle dimensions will vary per design, see drawings on spec.

Unit of Sale Box

Unit of Sale Net Weight (kg) 20.46

Performance

Fire Test Result	ISO 9705: Group 1, BS EN 13501.1: Classification B - s1, d0, ASTM E84 Unadhered: Class 1 or A
Acoustic Performance Standard Test Method	AS ISO 11654: 2002 (2016), AS ISO 354: 2006 (R2016), ASTM C423 - 17
Noise Reduction Coefficient (NRC) Result	Direct fix: 0.85
Sound Absorption Average (SAA) Result	Direct fix: 0.83
Weighted Sound Absorption Coefficient (α_w) Result	Direct fix: 0.75(MH)
Sound Absorption Class	C (Direct fix)
Equivalent Absorption Area (A_{eq}) in m^2 Sabins	Direct fix: 125Hz = 0.15m ² , 250Hz = 0.44m ² , 500Hz = 0.46m ² , 1000Hz = 0.70m ² , 2000Hz = 0.85m ² , and 4000Hz = 0.83m ²
Additional Acoustic Information	Baffles tested were 2400mm x 300mm x 24mm, at 300mm spacing/centres. MH = Mid to High Frequency
Colour Fastness to Light Standard Test Method	ISO 105 B02
Colour Fastness Light Rating	6 - 7
Light Reflectance Standard Test Method	ASTM E1477
Light Reflectance Value	Luminous Reflectance Factors (see table below for all colours): Dark (550 Onyx): 2.76, Mid (338 Jade): 20.52, Light (500 Off White): 80.44

Sustainability

VOC Emissions Results	EchoPanel 24mm achieves ASTM D5116: TVOC Emissions Rate: <0.02mg/m ² /hr (7 days), and CDPH Standard Method v1.2: TVOC Emissions Rate: <0.054mg/m ³ ; Formaldehyde Emissions Rate: <2µg/m ³
------------------------------	--

Sustainability Performance



Sustainability Performance Details

EchoPanel achieves GreenTag Certification GreenRate: Level A & Health Rate Platinum, Red List Free, and has an International Living Future Institute Declare Label. Array Baffles meet the sound reducing ceiling treatment requirements to attract points under feature S04 of WELL™ Standard v2.

Instructions

Additional Information

See Woven Image EchoPanel Care & Cleaning Guide.
See Woven Image Array Installation Guide.

Exact colour matching cannot be guaranteed between batches. Fibre mix and web variation are natural characteristics of this product.

ARRAY ACOUSTIC CEILING SYSTEM (AACS)

OVERVIEW



The Array Acoustic Ceiling System (AACS) is a fully scalable acoustic ceiling system that accommodates 12mm & 24mm EchoPanel® baffles. It features streamlined aluminium hardware that has been engineered for easy installation, and can be used in both ceiling or wall applications. Below hardware all sold separately.

HARDWARE OVERVIEW

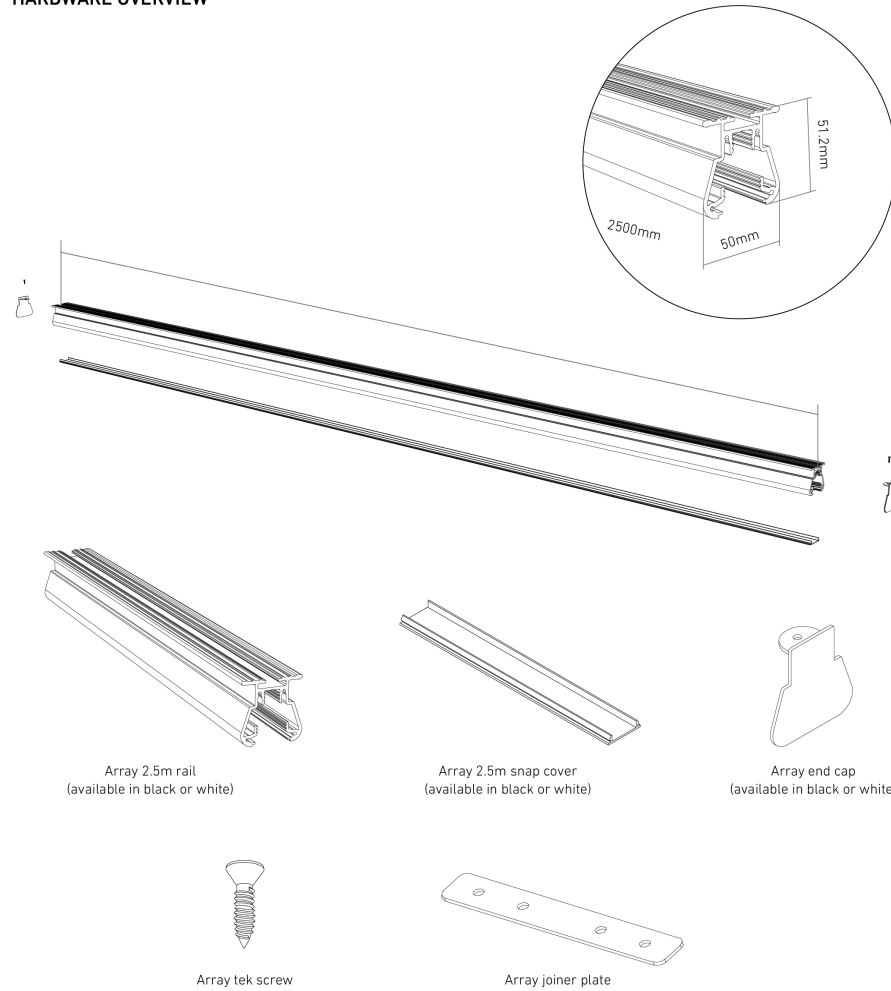

© Copyright Woven Image® Pty Ltd 2023, all rights reserved. This drawing may not be reproduced or transmitted in any form, or by any means in part or in whole, without the written permission of Woven Image® Pty Ltd

BEAM 200

ECHOPANEL® 24mm BAFFLE DESIGN



STANDARD BAFFLE SIZE

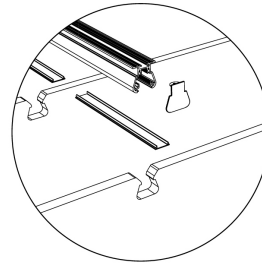
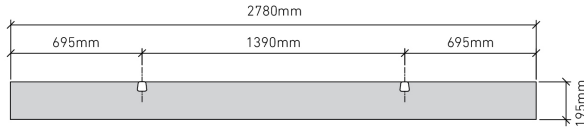

CUSTOM LENGTHS ON REQUEST

(Maximum length 2780mm)

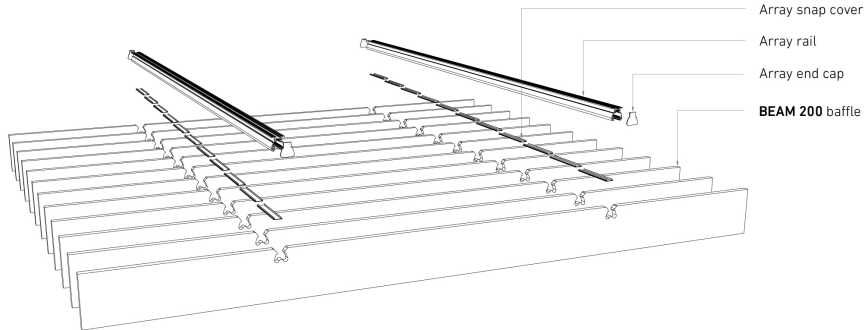
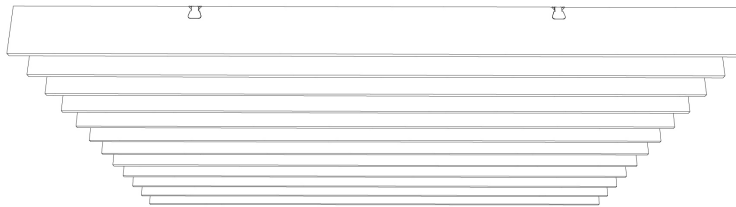
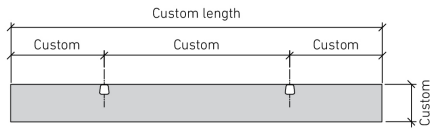

© Copyright Woven Image® Pty Ltd 2023, all rights reserved. This drawing may not be reproduced or transmitted in any form, or by any means in part or in whole, without the written permission of Woven Image® Pty Ltd

BEAM 300

ECHOPANEL® 24mm BAFFLE DESIGN



STANDARD BAFFLE SIZE

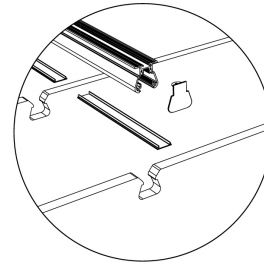
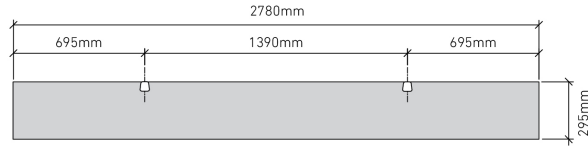

CUSTOM LENGTHS ON REQUEST

(Maximum length 2780mm)

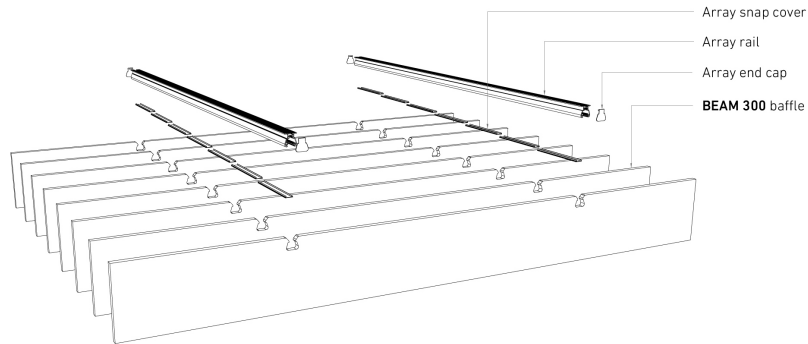
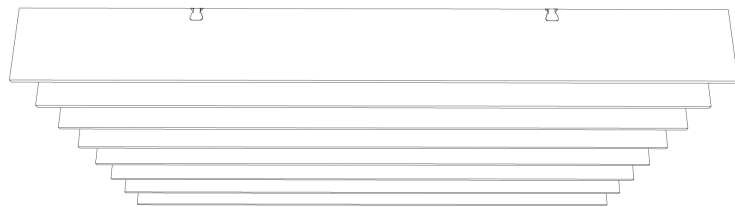
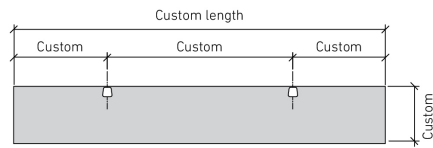

© Copyright Woven Image® Pty Ltd 2023, all rights reserved. This drawing may not be reproduced or transmitted in any form, or by any means in part or in whole, without the written permission of Woven Image® Pty Ltd

CATHEDRAL

ECHOPANEL® 24mm BAFFLE DESIGN



STANDARD BAFFLE SIZE

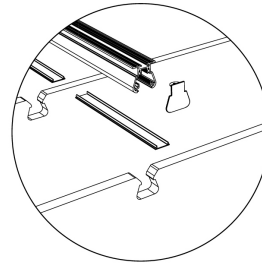
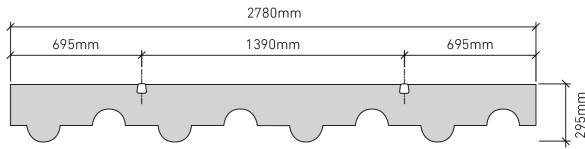

CUSTOM LENGTHS ON REQUEST

(Maximum length 2780mm)

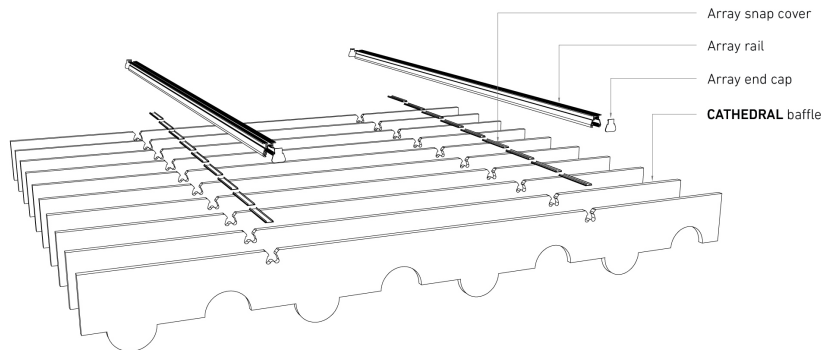
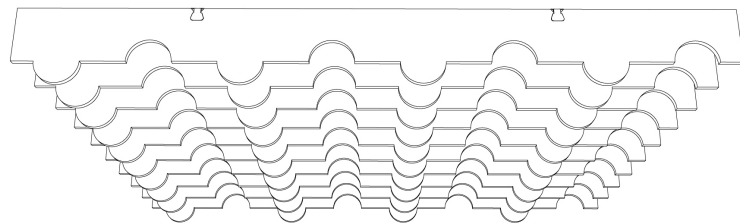
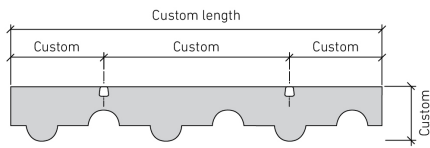

© Copyright Woven Image® Pty Ltd 2023, all rights reserved. This drawing may not be reproduced or transmitted in any form, or by any means in part or in whole, without the written permission of Woven Image® Pty Ltd

FLOW

ECHOPANEL® 24mm BAFFLE DESIGN



STANDARD BAFFLE SIZE

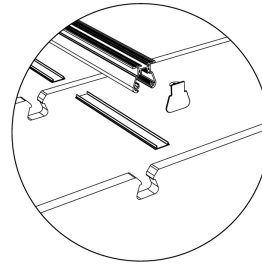
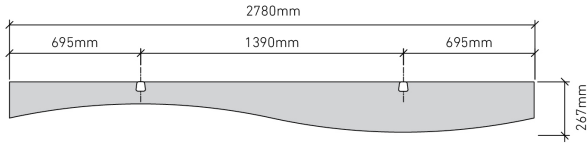

CUSTOM LENGTHS ON REQUEST

(Maximum length 2780mm)

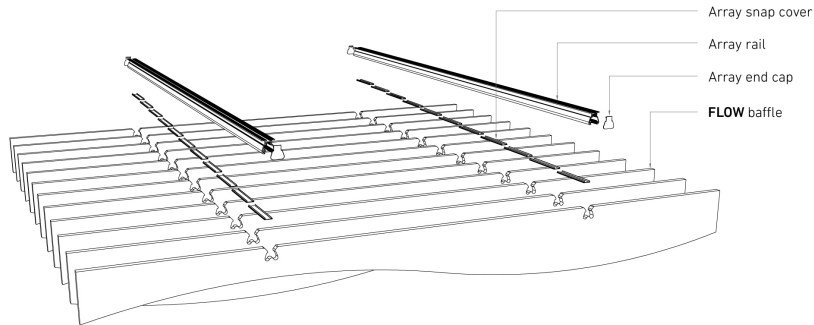
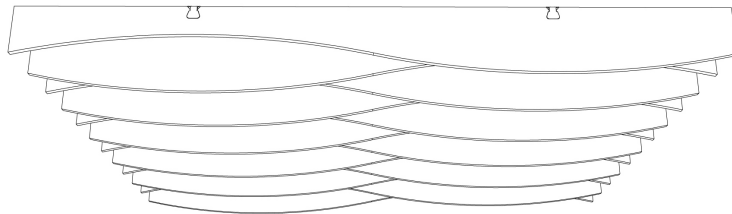
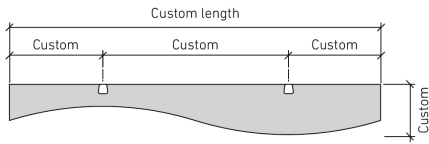

© Copyright Woven Image® Pty Ltd 2023, all rights reserved. This drawing may not be reproduced or transmitted in any form, or by any means in part or in whole, without the written permission of Woven Image® Pty Ltd

COLOUR CODE	COLOUR NAME	LUMINOUS REFLECTANCE FACTOR
550	ONYX	2.76
542	BLACK	5.36
330	IVY	7.30
269	WINE	7.34
365	NAVY	8.04
193	ROUGE	10.94
447	SLATE	11.88
484	CAYENNE	13.75
167	CINNAMON	14.44
349	VINEYARD	16.76
384	OLIVE	17.60
660	CORONET	19.07
295	MANDARIN	20.07
444	SMOKE	20.09
633	PACIFIC	20.38
338	JADE	20.52
402	PEBBLE	21.25
721	NUTMEG	26.62
442	GREY	30.40
580	SAGE	32.77
579	PISTACHIO	33.98
551	BLUE	35.67
124	OCHRE	36.09
274	ORCHID	38.14
487	BLUSH	40.06
495	DUSK	41.16
468	VANILLA	42.59
101	FROST	45.64
454	MUSHROOM	52.03
573	MINT	54.87
908	CREAM	60.13
106	BUTTER	69.31
381	LIME SPLICE	69.31
500	OFF WHITE	80.44

TAPER

ECHOPANEL® 24mm BAFFLE DESIGN



STANDARD BAFFLE SIZE

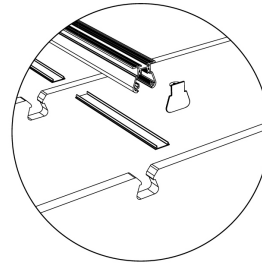
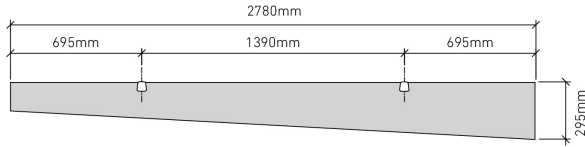

CUSTOM LENGTHS ON REQUEST

(Maximum length 2780mm)

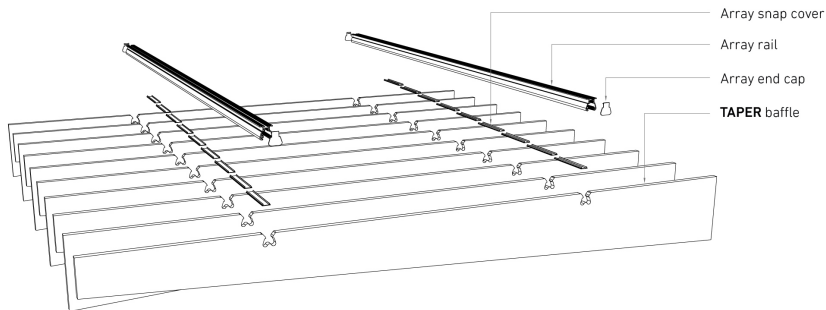
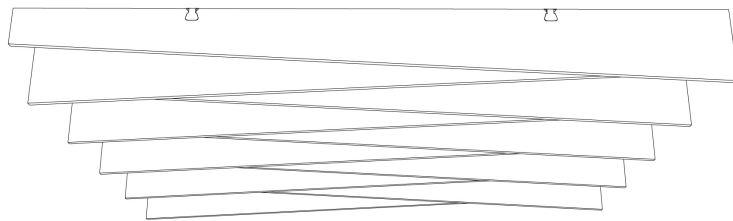
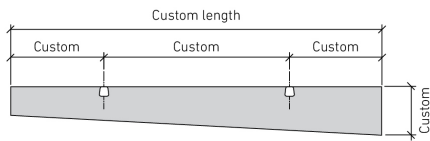

© Copyright Woven Image® Pty Ltd 2023, all rights reserved. This drawing may not be reproduced or transmitted in any form, or by any means in part or in whole, without the written permission of Woven Image® Pty Ltd

TURRET

ECHOPANEL® 24mm BAFFLE DESIGN



STANDARD BAFFLE SIZE

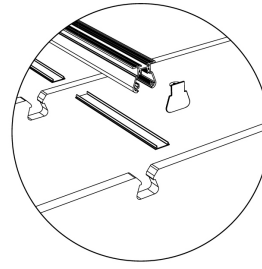
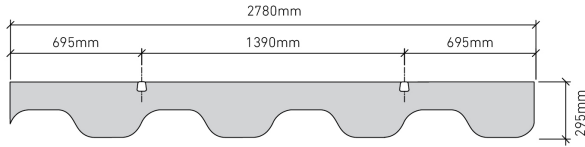

CUSTOM LENGTHS ON REQUEST

(Maximum length 2780mm)

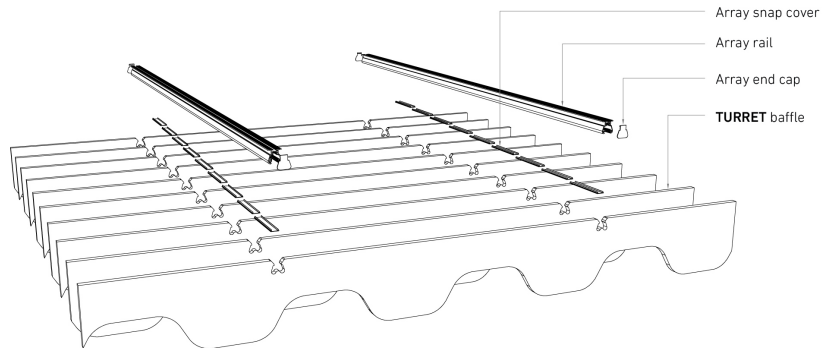
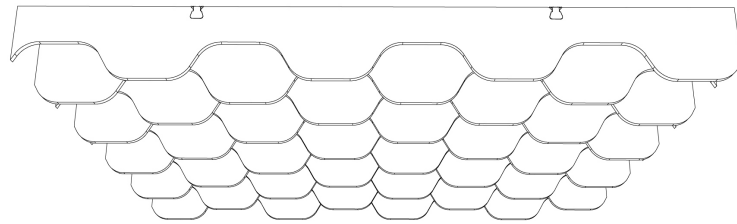
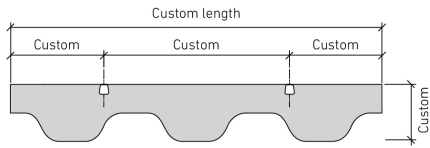

© Copyright Woven Image® Pty Ltd 2023, all rights reserved. This drawing may not be reproduced or transmitted in any form, or by any means in part or in whole, without the written permission of Woven Image® Pty Ltd

VALLEY

ECHOPANEL® 24mm BAFFLE DESIGN



STANDARD BAFFLE SIZE

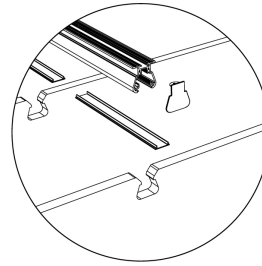
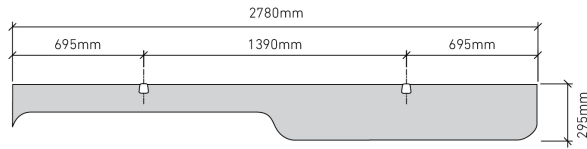

CUSTOM LENGTHS ON REQUEST

(Maximum length 2780mm)

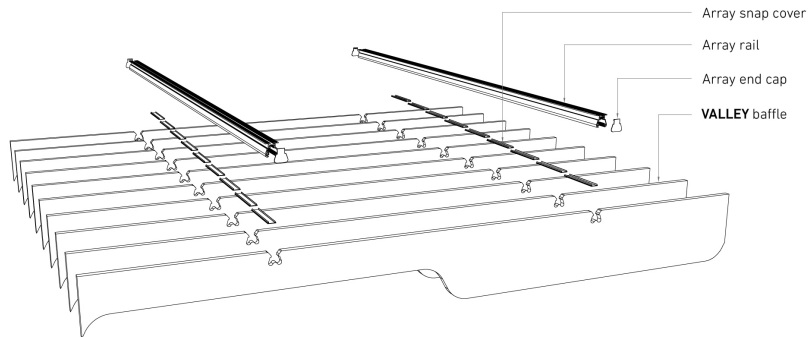
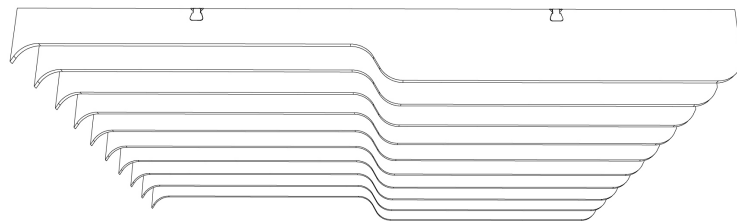
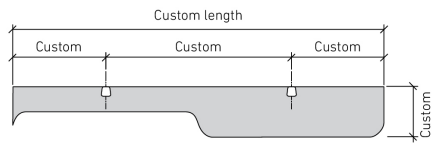

© Copyright Woven Image® Pty Ltd 2023, all rights reserved. This drawing may not be reproduced or transmitted in any form, or by any means in part or in whole, without the written permission of Woven Image® Pty Ltd

VIADUCT

ECHOPANEL® 24mm BAFFLE DESIGN



STANDARD BAFFLE SIZE

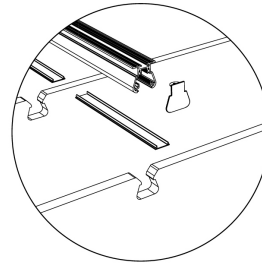
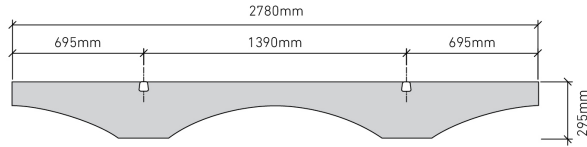

CUSTOM LENGTHS ON REQUEST

(Maximum length 2780mm)

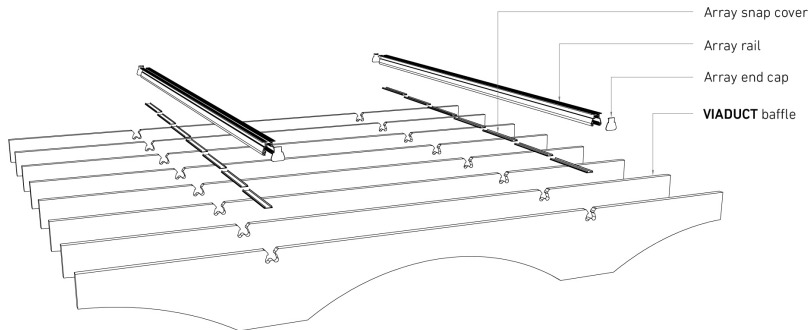
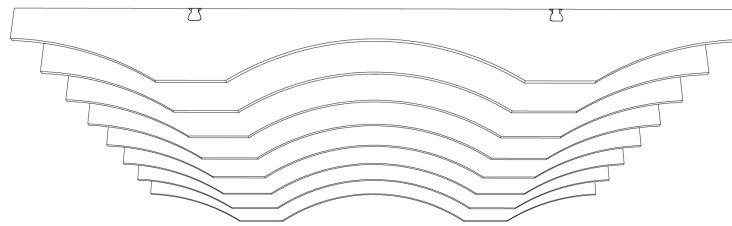
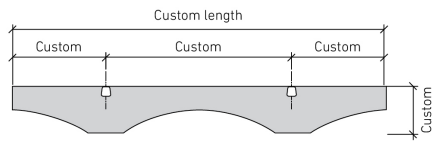

© Copyright Woven Image® Pty Ltd 2023, all rights reserved. This drawing may not be reproduced or transmitted in any form, or by any means in part or in whole, without the written permission of Woven Image® Pty Ltd

WAVE

ECHOPANEL® 24mm BAFFLE DESIGN



STANDARD BAFFLE SIZE

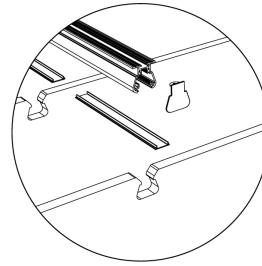
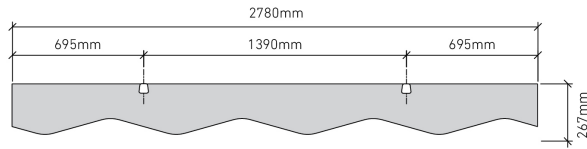

CUSTOM LENGTHS ON REQUEST

(Maximum length 2780mm)

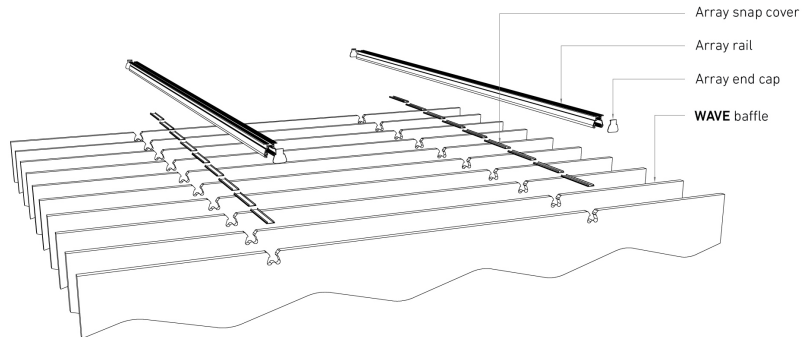
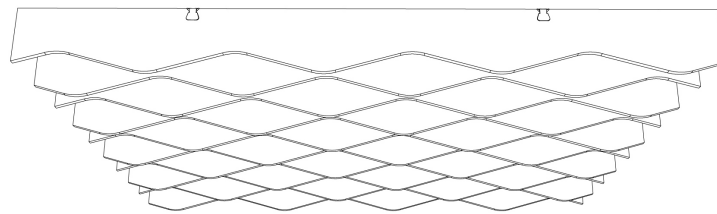
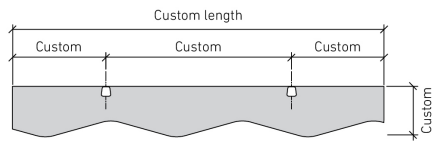

© Copyright Woven Image® Pty Ltd 2023, all rights reserved. This drawing may not be reproduced or transmitted in any form, or by any means in part or in whole, without the written permission of Woven Image® Pty Ltd

WEDGE 200

ECHOPANEL® 24mm BAFFLE DESIGN



STANDARD BAFFLE SIZE

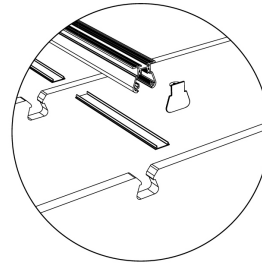
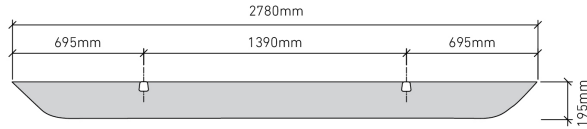

CUSTOM LENGTHS ON REQUEST

(Maximum length 2780mm)

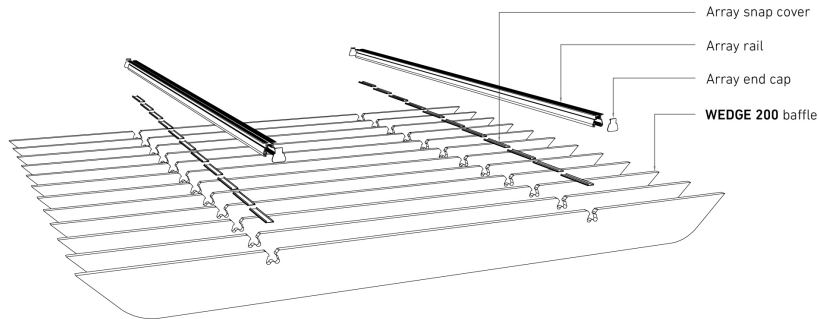
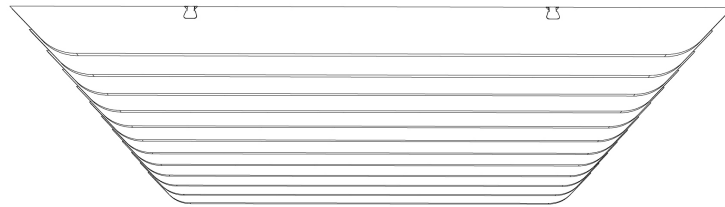
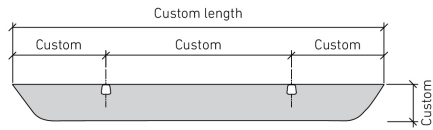

© Copyright Woven Image® Pty Ltd 2023, all rights reserved. This drawing may not be reproduced or transmitted in any form, or by any means in part or in whole, without the written permission of Woven Image® Pty Ltd

WEDGE 300

ECHOPANEL® 24mm BAFFLE DESIGN



STANDARD BAFFLE SIZE

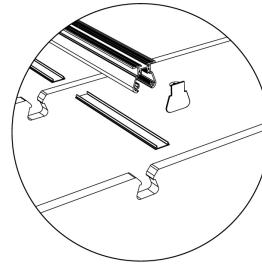
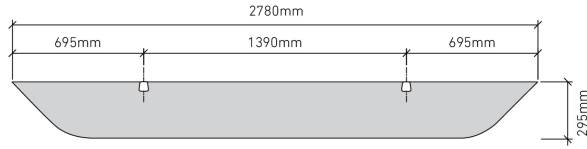

CUSTOM LENGTHS ON REQUEST

(Maximum length 2780mm)

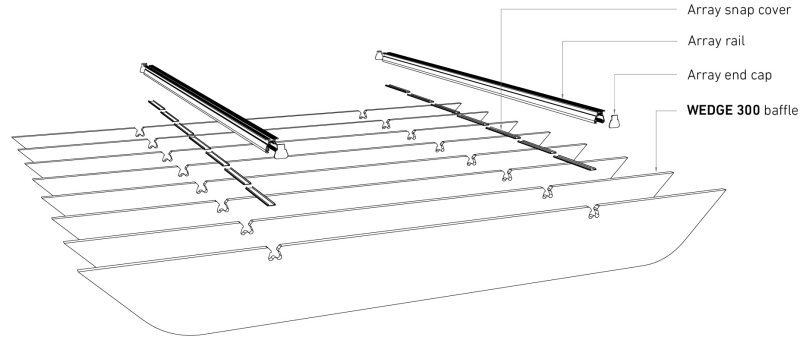
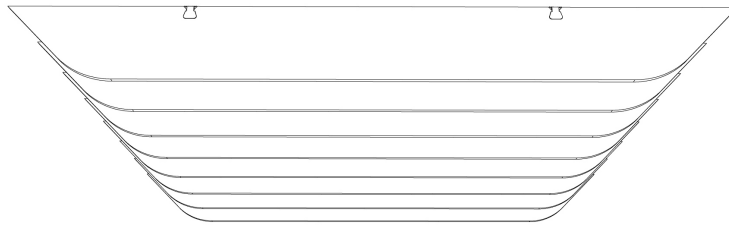
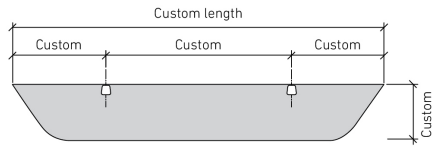

© Copyright Woven Image® Pty Ltd 2023, all rights reserved. This drawing may not be reproduced or transmitted in any form, or by any means in part or in whole, without the written permission of Woven Image® Pty Ltd