

---

# ACOUSTIC COLLECTION



# ACOUSTIC COLLECTION

- WOVEN IMAGE STORY ..... 02
- ECHOPANEL® COLLECTION..... 04
- CEILING COLLECTION..... 34
- SPACE DIVIDING COLLECTION..... 44
- MURA COLLECTION ..... 52
- HOOK & LOOP COLLECTION ..... 56
- EMBOSSSED PANEL COLLECTION..... 62
- 3D FORMED PANEL COLLECTION ..... 76
- ACOUSTIC TILE COLLECTION ..... 82
- ACOUSTIC FABRIC ..... 92
- PRINT DESIGNS ..... 94



Cover image: EchoPanel® ORB in colour 495 & on arch, EchoPanel® 12mm in colour 454

This image: BALANCE 1340 tile in colour 365

**Disclaimer** Due different screen configurations, images may not represent the true colour. Always confirm your colour choice with your Woven Image Representative.

We recommend requesting a sample prior to ordering.

ACOUSTIC COLLECTION

WOVEN IMAGE STORY



Established in 1987, Woven Image is an international interior finishes company with sustainability and design leadership at its core.

From humble beginnings in Sydney, Woven Image now has offices throughout Australia as well as Singapore, Hong Kong and China, and a network of distributors and stockists across all major markets including Europe and the UK, Asia and the Middle East, and The Americas.

The product portfolio consists of acoustic finishes such as EchoPanel®, suitable for wall, ceiling and space dividing applications in interior spaces including workplace, hospitality, education and healthcare sectors.

OUR ENVIRONMENTAL STORY

The Woven Image portfolio has been designed with dematerialisation, upcycling and lifecycle management front of mind. All base materials in this collection utilise recycled or waste materials and printed designs use non-toxic inks with low VOCs.

Woven Image achieves first-class environmental certifications for its key products, including Carbon Neutral Certification by Climate Active, Global GreenTag™ certification (GreenRate Level A), with the maximum Product Health Declaration™ Platinum Health and an Environmental Product Declaration (EPD). As a result, specifying these products can secure credits under sustainable building tools including Leadership in Energy and Environmental Design (LEED v4.1), WELL™ Building Standard and Green Star. Woven Image is also a long-term supporter of Greenfleet and offsets its carbon emissions through their bio-diverse program.

MANUFACTURING PROCESS OF ECHOPANEL® & MURA

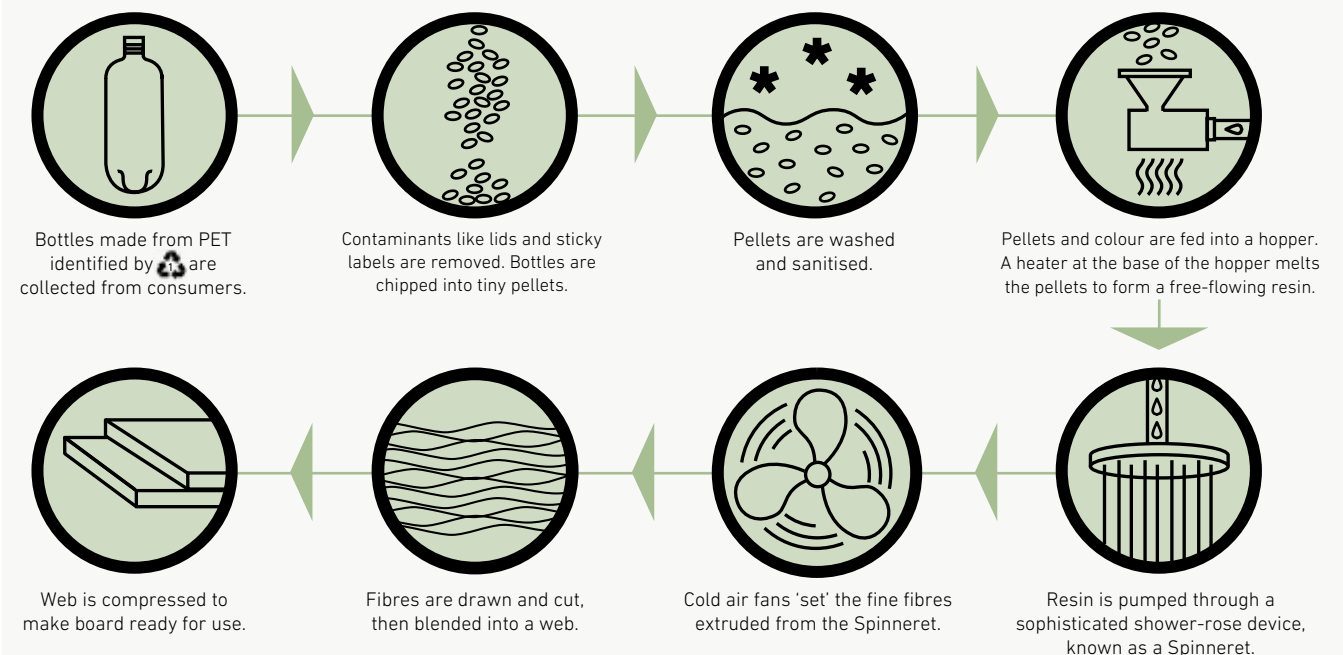

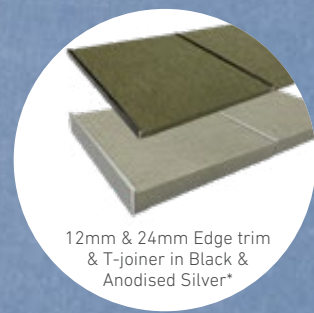

12mm & 24mm Edge trim & T-joiner in Black & Anodised Silver\*

Invented and launched by Woven Image in 2004, EchoPanel® is the original decorative interior panelling solution, with acoustic qualities and eco-innovation at its core. EchoPanel® production uses post-consumer recycled PET to create a superior upcycled product. Since 2022, Woven Image have also committed to offset the embodied carbon of EchoPanel® acoustic panels to zero. Since 2023, the EchoPanel® collection has achieved carbon neutrality, as certified by Climate Active.

EchoPanel® is available in a comprehensive range of neutral, mid-tone and vibrant colours. Due to its unique manufacturing process, the colour remains consistent throughout the depth of the panel.

EchoPanel® is pinnable, durable, lightweight and easy to cut and install, making it ideal for a multitude of wall, ceiling and free-standing commercial interior applications. Available in 12mm (0.47") and 24mm (0.94") thicknesses.

\*Aluminium panel trims are available for both 12mm and 24mm EchoPanel®, in Onyx and Silver Anodised finishes. T-joiners hide panel-to-panel joins, while Edge trims neatly cover panel edges.

# ECHOPANEL® COLLECTION

- ECHOPANEL® PALETTE..... 06
- PRECISION CUT DESIGNS..... 08
  - ECHOPANEL® ORB..... 10
  - ECHOPANEL® MOSAIC ..... 12
  - ECHOPANEL® CURRENT..... 14
  - ECHOPANEL® ISLE ..... 16
  - ECHOPANEL® PARQUET ..... 18
  - ECHOPANEL® LONGITUDE..... 20
  - ECHOPANEL® PALACE ..... 22
  - ECHOPANEL® OHM ..... 24
  - ECHOPANEL® EMPIRE ..... 26
  - ECHOPANEL® MERIDIAN ..... 28
  - ECHOPANEL® LATITUDE ..... 30
  - ECHOPANEL® ALIGN..... 32



EchoPanel® 12mm in colour 660



# ECHOPANEL® PALETTE



EchoPanel® MOSAIC in colour 573

**PANEL DIMENSIONS** 2800mm (+/-10mm) x 1200mm (+/-5mm) | 110.24" (+/-0.39") x 47.24" (+/-0.2")

**PANEL THICKNESS**  
**12mm** (+/-7%) | 0.47" (+/-7%)  
**24mm** (+/-7%) | 0.94" (+/-7%)

**SOUND ABSORPTION** AS ISO 354: 2006 (R2016) - direct fix results

**12mm** (0.47")  
 $\alpha_w$  0.30 (MH)  
 NRC 0.45  
 SAA 0.43  
 Class D

**24mm** (0.94")  
 $\alpha_w$  0.45 (MH)  
 NRC 0.65  
 SAA 0.63  
 Class D

## QUICK REFERENCE GUIDE

**PANEL DIMENSIONS**  
**12mm** x 2800mm x 1200mm | **0.47"** x 110.24" x 47.24"  
**24mm** x 2800mm x 1200mm | **0.94"** x 110.24" x 47.24"

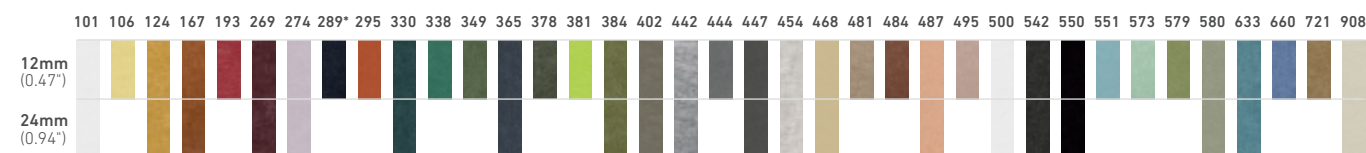

\*Colour Laguna 289 coming soon



500 Off White

101 Frost

442 Grey

908 Cream

454 Mushroom

468 Vanilla

402 Pebble

481 Latte

550 Onyx

542 Charcoal

447 Slate

444 Smoke

274 Orchid

269 Wine

193 Rouge

484 Cayenne

487 Blush

495 Dusk

167 Cinnamon

295 Mandarin

721 Nutmeg

124 Ochre

106 Butter

378 Seaweed

349 Vineyard

384 Olive

579 Pistachio

580 Sage

330 Ivy

338 Jade

573 Mint

381 Lime Splice

289 Laguna

365 Navy

660 Coronet

633 Pacific

551 Duck Egg

For additional specifications and performance details please visit [wovenimage.com](http://wovenimage.com) **HERE**

ECHOPANEL® COLLECTION

# PRECISION CUT DESIGNS



PRECISION CUT DESIGNS

## ECHOPANEL® ORB



EchoPanel® ORB in colour 495

<b>COLOURS</b>	Full EchoPanel® colour range - see page 7	<b>SOUND ABSORPTION</b>	AS ISO 354: 2006 (R2016) - direct fix results
<b>PANEL DIMENSIONS</b>	2750mm (+/-2mm) x 1100mm (+/-2mm)   108.27" (+/-0.08") x 43.31" (+/-0.08")		<b>12mm</b> $\alpha_w$ 0.30 (MH)
<b>PANEL THICKNESS</b>	<b>12mm</b> (+/-7%)   0.47" (+/-7%)		(0.47")    NRC        0.45
	<b>24mm</b> (+/-7%)   0.94" (+/-7%)		SAA        0.43
			Class      D
			<b>24mm</b> $\alpha_w$ 0.45 (MH)
			(0.94")    NRC        0.65
			SAA        0.63
			Class      D

For additional specifications and performance details please visit [wovenimage.com](https://wovenimage.com) **HERE**

PRECISION CUT DESIGNS

## ECHOPANEL® MOSAIC



EchoPanel® MOSAIC in colours 573 &amp; 721

<b>COLOURS</b>	Full EchoPanel® colour range - see page 7
<b>PANEL DIMENSIONS</b>	2750mm (+/-2mm) x 1100mm (+/-2mm)   108.27" (+/-0.08") x 43.31" (+/-0.08")
<b>PANEL THICKNESS</b>	<b>12mm</b> (+/-7%)   0.47" (+/-7%) <b>24mm</b> (+/-7%)   0.94" (+/-7%)

<b>SOUND ABSORPTION</b>	AS ISO 354: 2006 (R2016) - direct fix results	
<b>12mm</b> (0.47")	$\alpha_w$	0.30 (MH)
	NRC	0.45
	SAA	0.43
	Class	D
<b>24mm</b> (0.94")	$\alpha_w$	0.45 (MH)
	NRC	0.65
	SAA	0.63
	Class	D

---

For additional specifications and performance details please visit [wovenimage.com](https://wovenimage.com) **HERE**

---

PRECISION CUT DESIGNS

# ECHOPANEL® CURRENT



EchoPanel® CURRENT in colour 454

<b>COLOURS</b>	Full EchoPanel® colour range - see page 7
<b>PANEL DIMENSIONS</b>	2750mm (+/-2mm) x 1100mm (+/-2mm)   108.27" (+/-0.08") x 43.31" (+/-0.08")
<b>PANEL THICKNESS</b>	12mm (+/-7%)   0.47" (+/-7%) 24mm (+/-7%)   0.94" (+/-7%)

<b>SOUND ABSORPTION</b>	AS ISO 354: 2006 (R2016) - direct fix results	
<b>12mm</b> (0.47")	$\alpha_w$	0.30 (MH)
	NRC	0.45
	SAA	0.43
	Class	D
<b>24mm</b> (0.94")	$\alpha_w$	0.45 (MH)
	NRC	0.65
	SAA	0.63
	Class	D

For additional specifications and performance details please visit [wovenimage.com](http://wovenimage.com) **HERE**

PRECISION CUT DESIGNS

## ECHOPANEL® ISLE

EchoPanel® ISLE in colour 106

## COLOURS

Full EchoPanel® colour range - see page 7

## PANEL DIMENSIONS

2750mm (+/-2mm) x 1100mm (+/-2mm) | 108.27" (+/-0.08") x 43.31" (+/-0.08")

## PANEL THICKNESS

12mm (+/-7%) | 0.47" (+/-7%)

24mm (+/-7%) | 0.94" (+/-7%)

## SOUND ABSORPTION

AS ISO 354: 2006 (R2016) - direct fix results

<b>12mm</b>	$\alpha_w$	0.30 (MH)
(0.47")	NRC	0.45
	SAA	0.43
	Class	D

<b>24mm</b>	$\alpha_w$	0.45 (MH)
(0.94")	NRC	0.65
	SAA	0.63
	Class	D

---

For additional specifications and performance details please visit [wovenimage.com](https://wovenimage.com) **HERE**

---

PRECISION CUT DESIGNS

## ECHOPANEL® PARQUET



EchoPanel® PARQUET in colour 495

<b>COLOURS</b>	Full EchoPanel® colour range - see page 7
<b>PANEL DIMENSIONS</b>	2750mm (+/-2mm) x 1100mm (+/-2mm)   108.27" (+/-0.08") x 43.31" (+/-0.08")
<b>PANEL THICKNESS</b>	12mm (+/-7%)   0.47" (+/-7%) 24mm (+/-7%)   0.94" (+/-7%)

<b>SOUND ABSORPTION</b>	AS ISO 354: 2006 (R2016) - direct fix results	
<b>12mm</b> (0.47")	$\alpha_w$	0.30 (MH)
	NRC	0.45
	SAA	0.43
	Class	D
<b>24mm</b> (0.94")	$\alpha_w$	0.45 (MH)
	NRC	0.65
	SAA	0.63
	Class	D

For additional specifications and performance details please visit [wovenimage.com](https://wovenimage.com) **HERE**

PRECISION CUT DESIGNS

## ECHOPANEL® LONGITUDE



EchoPanel® LONGITUDE in colour 447

<b>COLOURS</b>	Full EchoPanel® colour range - see page 7
<b>PANEL DIMENSIONS</b>	2750mm (+/-2mm) x 1100mm (+/-2mm)   108.27" (+/-0.08") x 43.31" (+/-0.08")
<b>PANEL THICKNESS</b>	<b>12mm</b> (+/-7%)   0.47" (+/-7%) <b>24mm</b> (+/-7%)   0.94" (+/-7%)

<b>SOUND ABSORPTION</b>	AS ISO 354: 2006 (R2016) - direct fix results	
<b>12mm</b> (0.47")	$\alpha_w$	0.30 (MH)
	NRC	0.45
	SAA	0.43
	Class	D
<b>24mm</b> (0.94")	$\alpha_w$	0.45 (MH)
	NRC	0.65
	SAA	0.63
	Class	D

For additional specifications and performance details please visit [wovenimage.com](https://www.wovenimage.com) **HERE**

PRECISION CUT DESIGNS

# ECHOPANEL® PALACE



EchoPanel® PALACE in colour 349

<b>COLOURS</b>	Full EchoPanel® colour range - see page 7
<b>PANEL DIMENSIONS</b>	2750mm (+/-2mm) x 1100mm (+/-2mm)   108.27" (+/-0.08") x 43.31" (+/-0.08")
<b>PANEL THICKNESS</b>	<b>12mm</b> (+/-7%)   0.47" (+/-7%) <b>24mm</b> (+/-7%)   0.94" (+/-7%)

<b>SOUND ABSORPTION</b>	AS ISO 354: 2006 (R2016) - direct fix results	
<b>12mm</b> (0.47")	$\alpha_w$	0.30 (MH)
	NRC	0.45
	SAA	0.43
	Class	D
<b>24mm</b> (0.94")	$\alpha_w$	0.45 (MH)
	NRC	0.65
	SAA	0.63
	Class	D

For additional specifications and performance details please visit [wovenimage.com](https://wovenimage.com) **HERE**

PRECISION CUT DESIGNS

# ECHOPANEL® OHM

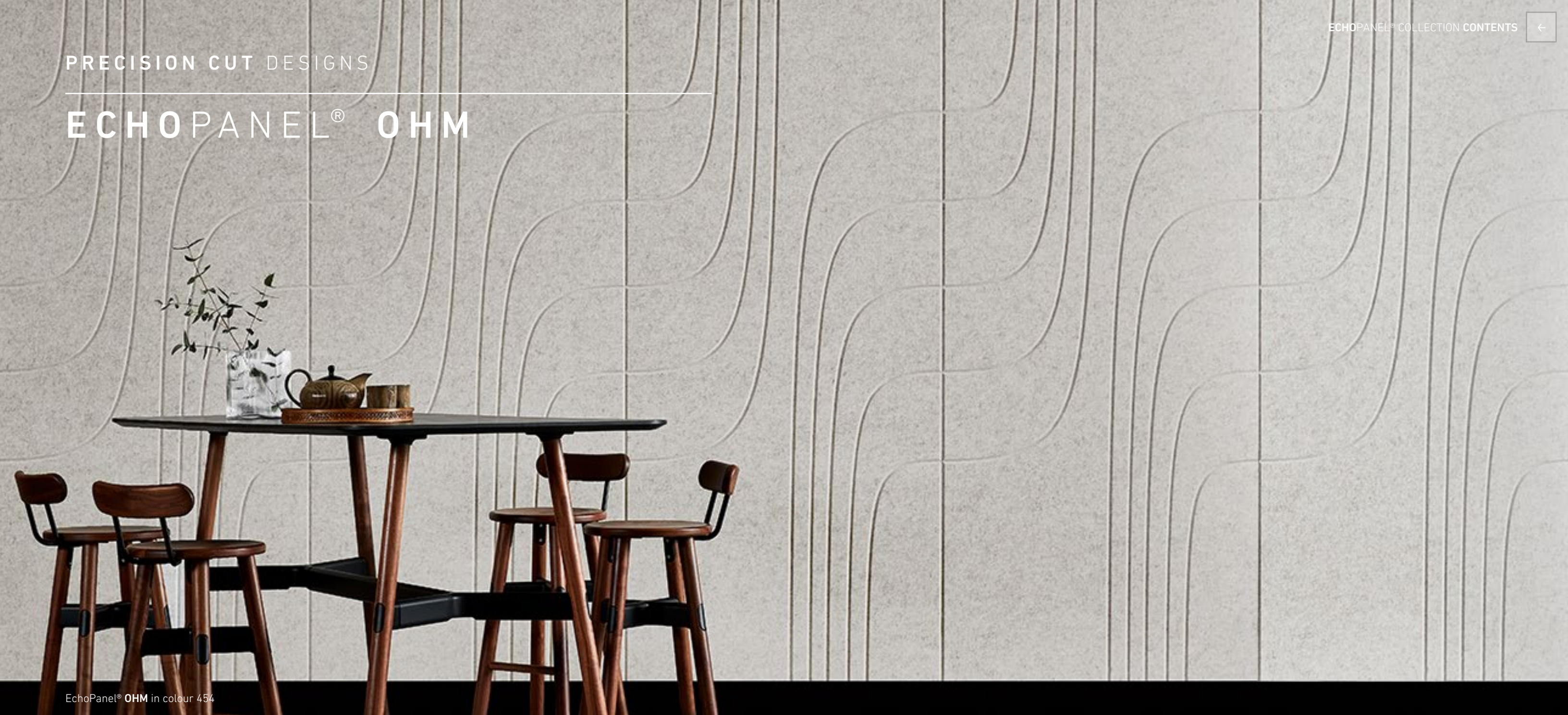

EchoPanel® OHM in colour 454

<b>COLOURS</b>	Full EchoPanel® colour range - see page 7
<b>PANEL DIMENSIONS</b>	2750mm (+/-2mm) x 1100mm (+/-2mm)   108.27" (+/-0.08") x 43.31" (+/-0.08")
<b>PANEL THICKNESS</b>	12mm (+/-7%)   0.47" (+/-7%) 24mm (+/-7%)   0.94" (+/-7%)

<b>SOUND ABSORPTION</b>	AS ISO 354: 2006 (R2016) - direct fix results	
<b>12mm</b> (0.47")	$\alpha_w$	0.30 (MH)
	NRC	0.45
	SAA	0.43
	Class	D
<b>24mm</b> (0.94")	$\alpha_w$	0.45 (MH)
	NRC	0.65
	SAA	0.63
	Class	D

For additional specifications and performance details please visit [wovenimage.com](http://wovenimage.com) **HERE**

PRECISION CUT DESIGNS

## ECHOPANEL® EMPIRE

EchoPanel® EMPIRE in colour 365

## COLOURS

Full EchoPanel® colour range - see page 7

## PANEL DIMENSIONS

2750mm (+/-2mm) x 1100mm (+/-2mm) | 108.27" (+/-0.08") x 43.31" (+/-0.08")

## PANEL THICKNESS

12mm (+/-7%) | 0.47" (+/-7%)

24mm (+/-7%) | 0.94" (+/-7%)

## SOUND ABSORPTION

AS ISO 354: 2006 (R2016) - direct fix results

<b>12mm</b>	$\alpha_w$	0.30 (MH)
(0.47")	NRC	0.45
	SAA	0.43
	Class	D

<b>24mm</b>	$\alpha_w$	0.45 (MH)
(0.94")	NRC	0.65
	SAA	0.63
	Class	D

For additional specifications and performance details please visit [wovenimage.com](https://wovenimage.com) **HERE**



PRECISION CUT DESIGNS

# ECHOPANEL® MERIDIAN



EchoPanel® MERIDIAN in colours 580 & 454

<b>COLOURS</b>	Full EchoPanel® colour range - see page 7
<b>PANEL DIMENSIONS</b>	2750mm (+/-2mm) x 1100mm (+/-2mm)   108.27" (+/-0.08") x 43.31" (+/-0.08")
<b>PANEL THICKNESS</b>	<b>12mm</b> (+/-7%)   0.47" (+/-7%) <b>24mm</b> (+/-7%)   0.94" (+/-7%)

<b>SOUND ABSORPTION</b>	AS ISO 354: 2006 (R2016) - direct fix results	
<b>12mm</b> (0.47")	$\alpha_w$	0.30 (MH)
	NRC	0.45
	SAA	0.43
	Class	D
<b>24mm</b> (0.94")	$\alpha_w$	0.45 (MH)
	NRC	0.65
	SAA	0.63
	Class	D

For additional specifications and performance details please visit [wovenimage.com](http://wovenimage.com) **HERE**

PRECISION CUT DESIGNS

## ECHOPANEL® LATITUDE



EchoPanel® LATITUDE in colour 384

<b>COLOURS</b>	Full EchoPanel® colour range - see page 7
<b>PANEL DIMENSIONS</b>	2750mm (+/-2mm) x 1100mm (+/-2mm)   108.27" (+/-0.08") x 43.31" (+/-0.08")
<b>PANEL THICKNESS</b>	<b>12mm</b> (+/-7%)   0.47" (+/-7%) <b>24mm</b> (+/-7%)   0.94" (+/-7%)

<b>SOUND ABSORPTION</b>	AS ISO 354: 2006 (R2016) - direct fix results	
<b>12mm</b> (0.47")	$\alpha_w$	0.30 (MH)
	NRC	0.45
	SAA	0.43
	Class	D
<b>24mm</b> (0.94")	$\alpha_w$	0.45 (MH)
	NRC	0.65
	SAA	0.63
	Class	D

For additional specifications and performance details please visit [wovenimage.com](https://wovenimage.com) **HERE**

PRECISION CUT DESIGNS

# ECHOPANEL® ALIGN



EchoPanel® ALIGN in colour 349

<b>COLOURS</b>	Full EchoPanel® colour range - see page 7
<b>PANEL DIMENSIONS</b>	2750mm (+/-2mm) x 1180mm (+/-2mm)   108.27" (+/-0.08") x 46.46" (+/-0.08")
<b>PANEL THICKNESS</b>	<b>12mm</b> (+/-7%)   0.47" (+/-7%) <b>24mm</b> (+/-7%)   0.94" (+/-7%)

<b>SOUND ABSORPTION</b>	AS ISO 354: 2006 (R2016) - direct fix results	
<b>12mm</b> (0.47")	$\alpha_w$	0.30 (MH)
	NRC	0.45
	SAA	0.43
	Class	D
<b>24mm</b> (0.94")	$\alpha_w$	0.45 (MH)
	NRC	0.65
	SAA	0.63
	Class	D

For additional specifications and performance details please visit [wovenimage.com](https://wovenimage.com) **HERE**

# CEILING COLLECTION

ECHOPANEL® ARRAY ..... 36

FUJI ..... 40

Woven Image offer design-driven and high-performance acoustic ceiling solutions, to control reverberated noise in commercial interior spaces.

EchoPanel® Array is an acoustic ceiling baffle solution utilising 24mm (0.94") EchoPanel®, with streamlined hardware engineered for easy installation, and scalable for both small and large applications. Choose from beautifully crafted baffles in the extensive EchoPanel® colour palette, or work with us to create your own unique designs.

Fuji is a range of decorative 3D formed ceiling tiles, offering superb acoustic absorption. Fuji tiles can be installed with or without the Array ceiling hardware, with options to direct-fix or suspend from the ceiling and integrate a variety of lighting options.

Woven Image's inhouse Commercial Service team provide industry expertise, advice and CAD technical plans and drawings, to ensure ceiling projects are delivered to the highest standards.



FUJI ROKU in colour 420 with onyx/gold barrel kits



CEILING COLLECTION

# ECHOPANEL® ARRAY

EchoPanel® Array baffle and ceiling hardware dimensions will vary depending on project requirements. Exact quantities, measurements and drawings will be provided upon project specification.

Standard baffle designs are 2780mm in length and vary in depth, please see below:

**BEAM**



2780mm length x 200mm depth (+/-5mm)



2780mm length x 300mm depth (+/-5mm)

**WEDGE**

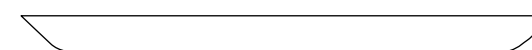

2780mm length x 200mm depth (+/-5mm)

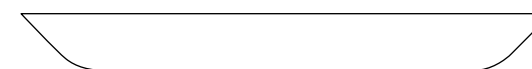

2780mm length x 300mm depth (+/-5mm)

**TAPER**

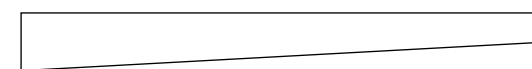

2780mm length x 300mm depth (+/-5mm)

**CATHEDRAL**

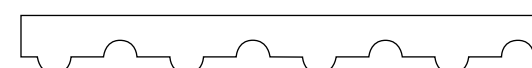

2780mm length x 300mm depth (+/-5mm)

**TURRET**

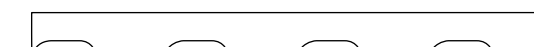

2780mm length x 300mm depth (+/-5mm)

**VALLEY**



2780mm length x 300mm depth (+/-5mm)

**VIADUCT**

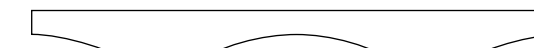

2780mm length x 300mm depth (+/-5mm)

**WAVE**



2780mm length x 267mm depth (+/-5mm)

**FLOW**

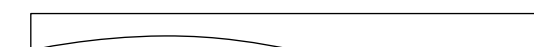

2780mm length x 300mm depth (+/-5mm)

For additional specifications and performance details please visit [wovenimage.com](http://wovenimage.com) **HERE**



CEILING COLLECTION

## ECHOPANEL® ARRAY

ECHOPANEL® 24mm in colours 384, 468 & 580 & ECHOPANEL® 12mm in colours 167, 269 & 468  
 Project: University of Adelaide | Designer: Architectus | Photography: Aaron Citti

## COLOURS

Full EchoPanel® colour range - see page 7

## DIMENSIONS

For standard baffle styles & dimensions - see page 37

## SOUND ABSORPTION

**24mm** (+/-7%) | 0.94" (+/-7%) - direct fix results

AS ISO 354: 2006 (R2016)

AS ISO 11654: 2002 (2016)

ASTM C423 - 17

$\alpha_w$  0.75 (MH)

NRC 0.85

SAA 0.83

Class C

For additional specifications and performance details please visit [wovenimage.com](http://wovenimage.com) **HERE**



CEILING COLLECTION

FUJI

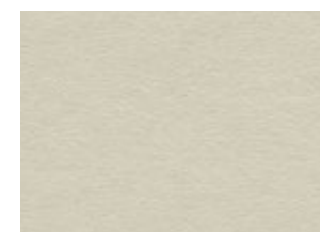

908 Cream



550 Onyx



299 Duck Egg/Cream



420 Cream/Onyx



ARRAY RAILS in colours black & white



BARREL KITS in colours onyx, off-white & onyx/gold

COLOURS

Stocked in 4 standard colours – full Mura colour range available on request, see page 54. Barrel kits allow Fuji tiles to be directly fixed to the ceiling or to the Array ceiling rail.

DIMENSIONS

**FUJI JUNI** 560mm (+/-3mm) x 1160mm (+/-3mm) x 90mm (+/-3mm)  
22.05" (+/-0.12") x 45.67" (+/-0.12") x 3.54" (+/-0.12")

**FUJI HACHI** 1740mm (+/-3mm) x 840mm (+/-3mm) x 132mm (+/-3mm)  
68.5" (+/-0.12") x 33.07" (+/-0.12") x 5.2" (+/-0.12")

THICKNESS

4.6mm (+/-2mm) | 0.18" (+/-0.08")

SOUND ABSORPTION

AS ISO 11654: 2002 (2016) | AS ISO 354: 2006 (R2016) | ASTM C423 - 17, with perimeter

<b>FUJI JUNI</b>	$\alpha_w$	0.80
	NRC	0.80
	SAA	0.76
<b>FUJI HACHI</b>	$\alpha_w$	0.85
	NRC	0.80
	SAA	0.76

For additional specifications and performance details please visit [wovenimage.com](http://wovenimage.com) **HERE**

CEILING COLLECTION

FUJI



FUJI KU in colour 550 | Project: JQZ Office | Design & Installation: Sheldon Interiors | Photographer: Simon Whitbread

**COLOURS** Stocked in 4 standard colours – full Mura colour range available on request, see page 58. Barrel kits allow Fuji tiles to be directly fixed to the ceiling or to the Array ceiling rail.

**DIMENSIONS**

**FUJI ROKU** 560mm (+/-3mm) x 560mm (+/-3mm) x 90mm (+/-3mm)  
22.05" (+/-0.12") x 22.05" (+/-0.12") x 3.54" (+/-0.12")

**FUJI KU** 840mm (+/-3mm) x 840mm (+/-3mm) x 132mm (+/-3mm)  
33.07" (+/-0.12") x 33.07" (+/-0.12") x 5.2" (+/-0.12")

**THICKNESS** 4.6mm (+/-2mm) | 0.18" (+/-0.08")

**SOUND ABSORPTION** AS ISO 11654: 2002 (2016) | AS ISO 354: 2006 (R2016) | ASTM C423 - 17, with perimeter

<b>FUJI ROKU</b>	αw	0.75
	NRC	0.70
	SAA	0.72
<b>FUJI KU</b>	αw	0.80
	NRC	0.75
	SAA	0.74

For additional specifications and performance details please visit [wovenimage.com](http://wovenimage.com) **HERE**

# SPACE DIVIDING COLLECTION

Our range of EchoPanel® space dividing systems includes hanging pendants and free-standing room dividers.

These products allow open plan spaces, typical of modern workplace and hospitality environments, to be partitioned with ease and flexibility whilst reducing reverberated noise to improve both comfort and productivity.

HANGING PENDENTS.....	46
PALING.....	48
PLATOON.....	50



## SPACE DIVIDING COLLECTION

## HANGING PENDENTS

12mm | 0.47"

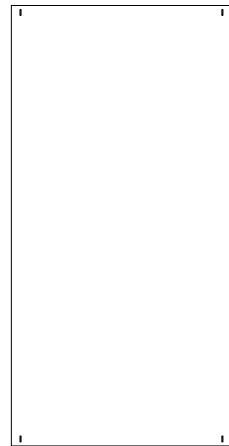

TANDEM 12mm | 0.47"

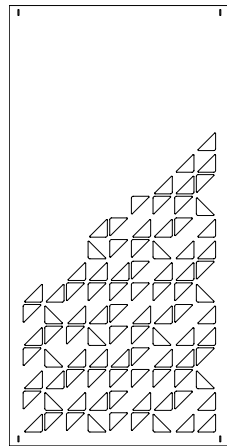

SUMMIT 12mm | 0.47"

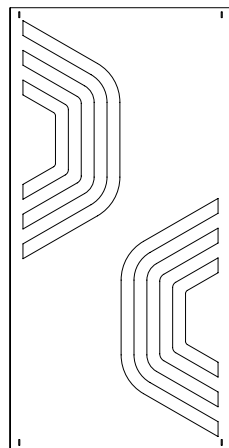

DOT 12mm | 0.47"

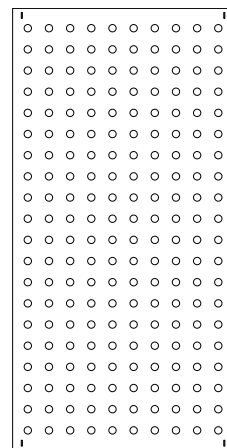

SPLAY 12mm | 0.47"

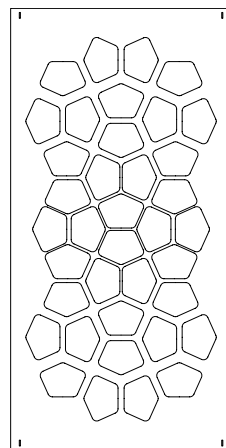

## COLOURS

Full EchoPanel® 12mm (0.47") colour range - see page 7

## PENDENT DESIGNS

5 styles

## PANEL DIMENSIONS

12mm (+/-7%) | 0.47" (+/-7%)  
 2400mm (+/-2mm) x 1200mm (+/-10mm)  
 94.49" (+/-0.08") x 47.24" (+/-0.39")

## SOUND ABSORPTION

See EchoPanel® 12mm (0.47") on page 6 for details

## BOX COMPONENTS

1 x cut EchoPanel® 12mm (0.47")  
 1 x 12mm hanging pendent component kit

For additional specifications and performance details please visit [wovenimage.com](http://wovenimage.com) **HERE**

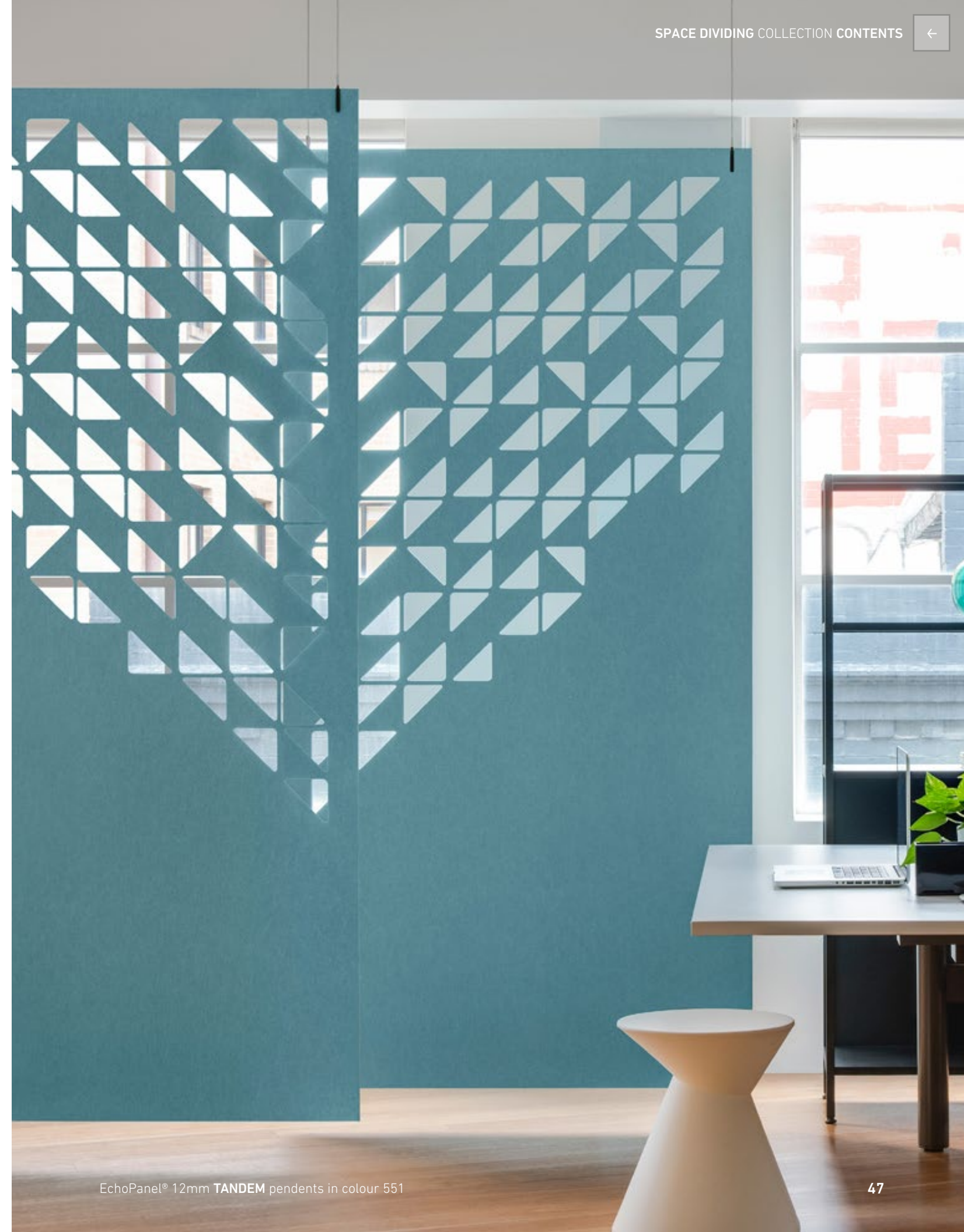

## SPACE DIVIDING COLLECTION

## PALING

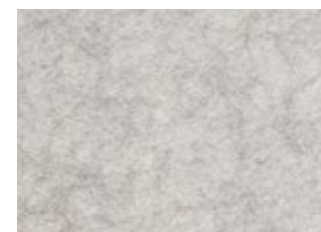

454 Mushroom

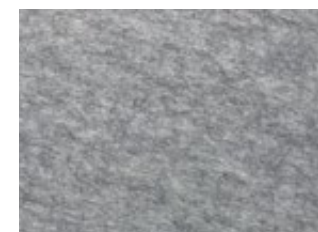

442 Grey

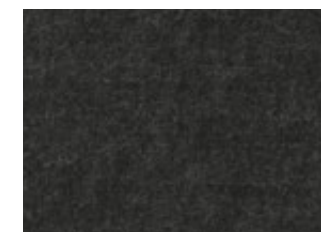

542 Charcoal

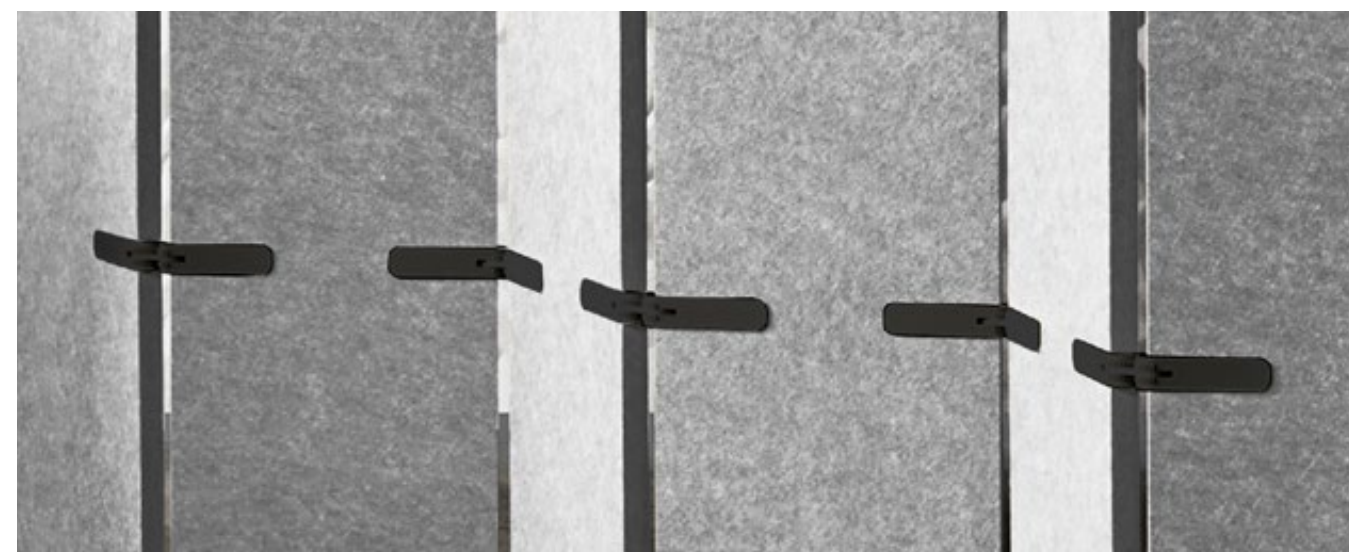

EchoPanel® PALING in colour 442 with charcoal pivot joiners

<b>PRODUCT TYPE</b>	Free-standing system
<b>PANEL DIMENSIONS</b>	<b>PALING A (end panel) &amp; B (middle panel)</b> 285mm (+/-2mm) x 1750mm (+/-2mm) 11.22" (+/-0.08") x 68.9" (+/-0.08")
<b>PANEL THICKNESS</b>	<b>24mm (+/-7%)   0.94" (+/-7%)</b>
<b>PIVOT JOINER COLOURS</b>	Cream and charcoal - to be specified in order
<b>SOUND ABSORPTION</b>	See EchoPanel® 24mm (0.94") on page 6 for details

For additional specifications and performance details please visit [wovenimage.com](https://wovenimage.com) **HERE**

## SPACE DIVIDING COLLECTION

## PLATOON



PLATOON in colours 442 &amp; 542 with charcoal pivot joiners

<b>PRODUCT TYPE</b>	Free-standing system
<b>FULL PRODUCT DIMENSIONS</b>	1750mm (+/-2mm) x 3500mm (+/-2mm) 68.9" (+/-0.08") x 137.8" (+/-0.08")
<b>PANEL THICKNESS</b>	<b>24mm</b> (+/-7%)   0.94" (+/-7%)
<b>PIVOT JOINER COLOURS</b>	Cream and charcoal - to be specified in order
<b>SOUND ABSORPTION</b>	See EchoPanel® 24mm (0.94") on page 6 for details
<b>BOX COMPONENTS</b>	6 x <b>PLATOON</b> panels 10 x pivot joiners

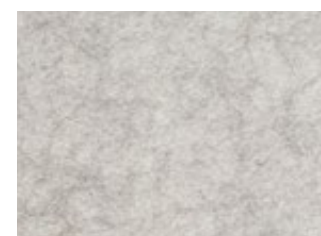

454 Mushroom

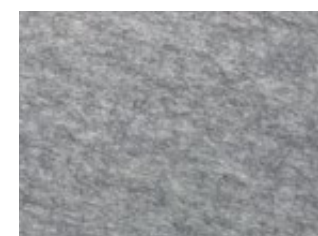

442 Grey

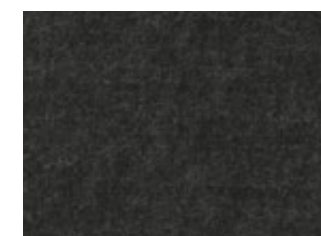

542 Charcoal

For additional specifications and performance details please visit [wovenimage.com](http://wovenimage.com) **HERE**

# MURA COLLECTION

Mura is an innovative and versatile, 1.9mm (0.075") thick, surface finish that is highly cost effective, easy to install and boasts an on-trend colour palette. The face side has been designed to create a smooth clean look, whilst the back has been engineered with a forgiving texture that can be adhered to a variety of surfaces including walls, workstation screens and operable walls.

Made from 60% recycled PET with low VOCs, Mura has the same first-rate environmental certifications as EchoPanel®.

MURA PALETTE ..... 54



Desk screen in MURA colour 551 with wall in MURA colour 454

MURA COLLECTION

MURA PALETTE

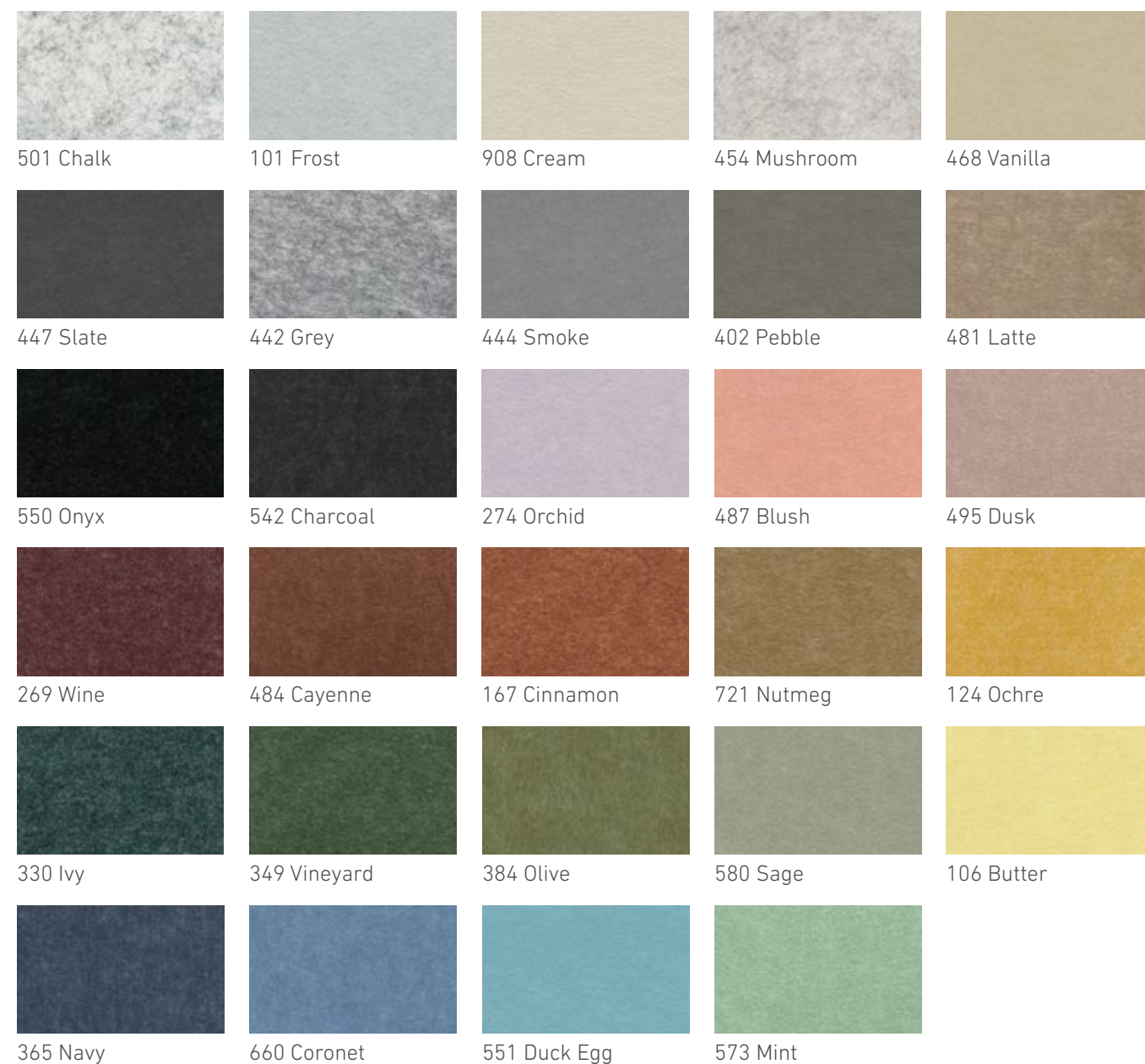

**ROLL DIMENSIONS** 6m, 25m or 105m roll | 236", 984" or 4134" roll

**ROLL WIDTH** 1210mm (+/-5mm) | 47.64" (+/-0.2")

**THICKNESS** 1.9mm (+/-0.25mm) | 0.07" (+/-0.01")

**SOUND ABSORPTION** AS ISO 354: 2006 (R2016) - direct fix results

αw	0.10 (H)
NRC Value	0.10
SAA	0.08

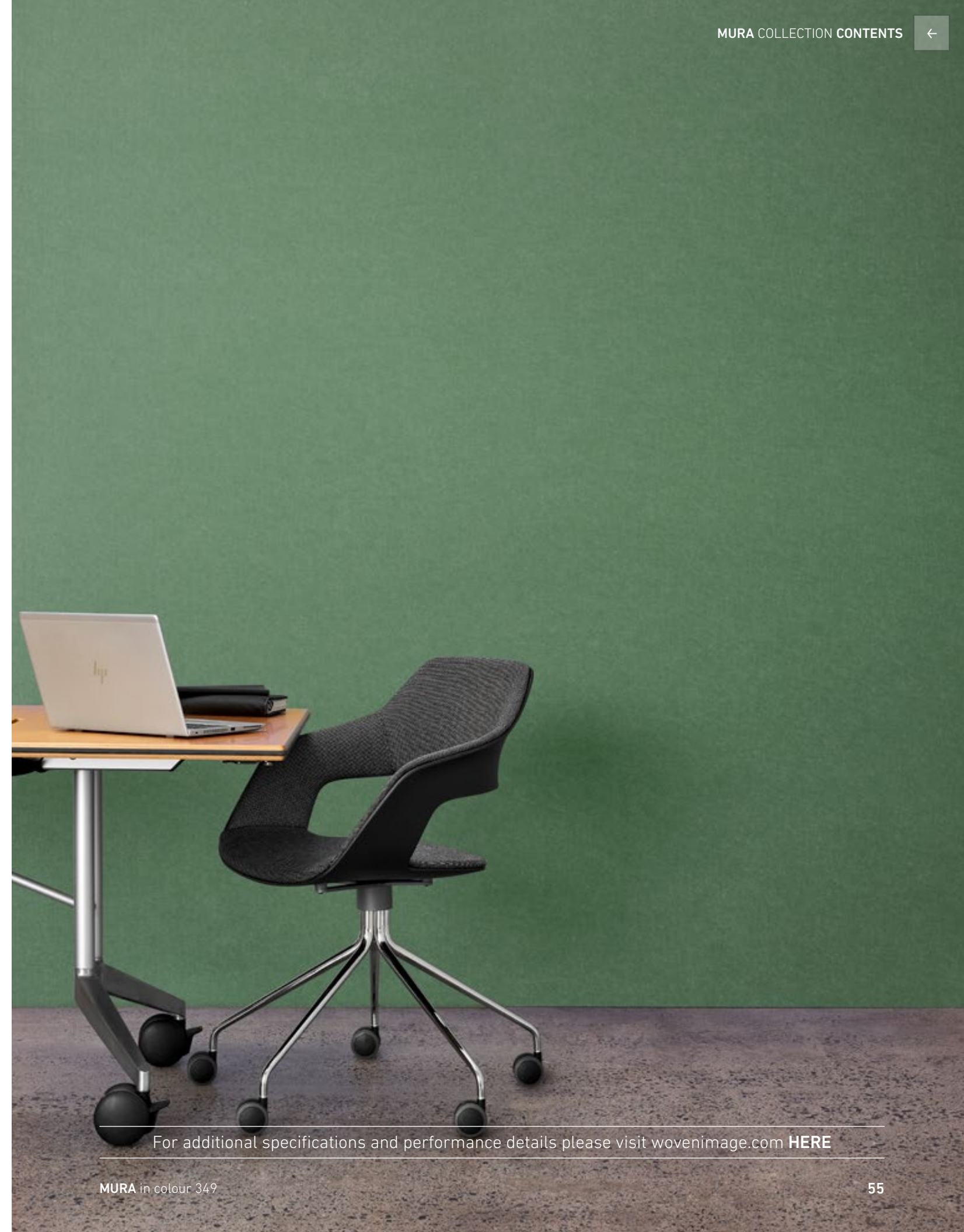

For additional specifications and performance details please visit [wovenimage.com](http://wovenimage.com) **HERE**



25mm & 50mm Edge trim & T-joiner in Black & Anodised Silver\*

# HOOK & LOOP COLLECTION

HOOK & LOOP PALETTE ..... 58

ECHOFLEX™ ..... 59

ECHOVELOUR™ ..... 60

The Hook & Loop Collection combines acoustic performance with versatile, user-friendly functionality for environments where adaptability is essential. Ideal for learning environments and aged care settings, these solutions support flexible wall applications for communication, display, and comfort. Featuring integrated hook-and-loop velcro-compatible surfaces and a curated colour palette, the collection delivers both functional performance and cohesive, design-led outcomes.

ECHOFLEX™ is a lightweight wallcovering with a soft velour finish, designed for flexibility and ease of installation. Easily cut and applied to curved or irregular surfaces, it enables creative applications while maintaining durability and reliable performance.

ECHOVELOUR™ wall panels offer high acoustic performance paired with a soft velour surface, providing a practical and refined solution for acoustically demanding spaces.

A coordinated palette of 22 colours aligns seamlessly with each other and EchoPanel®, enabling cohesive, design-led outcomes across interior spaces.

\*Aluminium panel trims are available for both 25mm and 50mm ECHOVELOUR™ in Onyx and Silver Anodised finishes. T-joiners hide panel-to-panel joins, while Edge trims neatly cover panel edges.

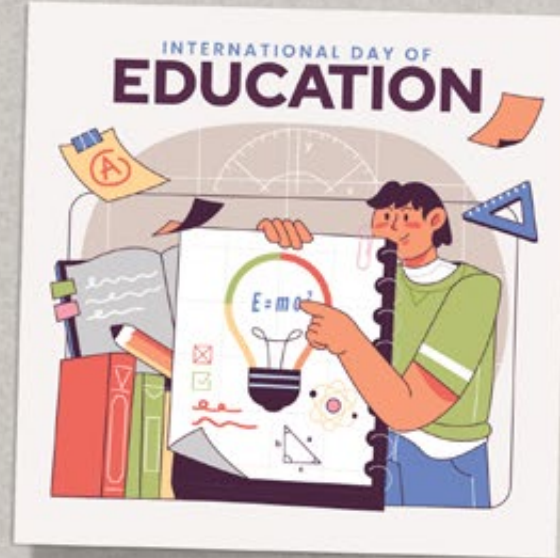

ECHOVELOUR™ in colour 454



HOOK & LOOP COLLECTION

HOOK & LOOP PALETTE

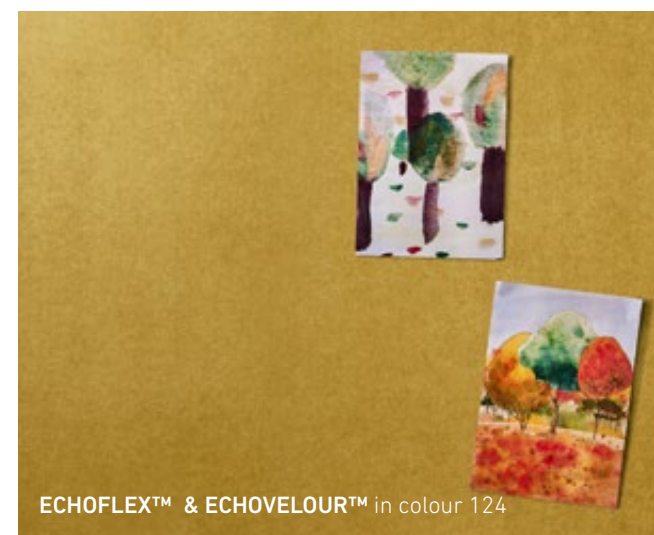

For additional specifications and performance details please visit [wovenimage.com](http://wovenimage.com) **HERE**

HOOK & LOOP COLLECTION

ECHOFLEX™



**COLOURS** Full Hook & Loop colour range - see page 58

**ROLL DIMENSIONS** 25m (+/-25mm) | 984" (+/-0.98")

**ROLL WIDTH** 1220mm (+/-2mm) | 48" (+/-0.08")

**THICKNESS** **10-12mm** (+/-2mm) | 0.39"-0.47" (+/-0.01")

**SOUND ABSORPTION** AS ISO 354: 2006 (R2016) | AS ISO 11654: 2002 (2016)

ASTM C423 - 17 - direct fix results

αw 0.35 (H)

NRC 0.40

SAA 0.41

For additional specifications and performance details please visit [wovenimage.com](http://wovenimage.com) **HERE**

HOOK & LOOP COLLECTION

ECHOVELOUR™

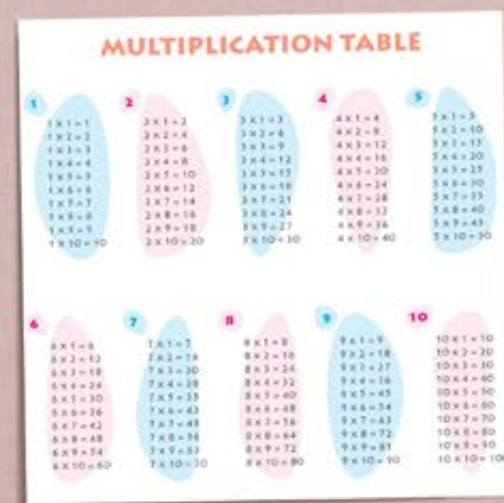

ECHOVELOUR™ in colour 495

<b>COLOURS</b>	Full Hook & Loop colour range - see page 58
<b>PANEL DIMENSIONS</b>	<b>25mm</b> 2800mm (+/-10mm) x 1210mm (+/-5mm)   110.24" (+/-0.39") x 47.64" (+/-0.2") <b>50mm</b> 2800mm (+/-10mm) x 1210mm (+/-5mm)   110.24" (+/-0.39") x 47.64" (+/-0.2")
<b>PANEL THICKNESS</b>	<b>25mm</b> (+/-8%)   0.98" (+/-8%) <b>50mm</b> (+/-4%)   1.97" (+/-4%)

<b>SOUND ABSORPTION</b>	AS ISO 354: 2006 (R2016) - direct fix results	
<b>25mm</b> (0.98")	$\alpha_w$	0.8 (H)
	NRC	0.85
	SAA	0,86
	Class	B
<b>50mm</b> (1.97")	$\alpha_w$	1.0
	NRC	1.0
	SAA	0.98
	Class	A

For additional specifications and performance details please visit [wovenimage.com](http://wovenimage.com) **HERE**



9mm Edge trim & T-joiner in Black & Anodised Silver\*



# EMBOSSSED PANEL COLLECTION

PICO .....	64
ZEN .....	66
ION .....	68
GEM .....	70
UMI .....	72
NALU .....	74

The embossed acoustic panel collection from Woven Image is made using recycled PET. This design-led range embraces the trend towards tactile surfaces and three-dimensional textures, interweaving cutting-edge design with sustainability and commercial performance.

Available in six unique designs; Zen, Ion, Gem, Pico, Umi and Nalu which have been specially designed to provide a floor-to-ceiling acoustic solution for commercial office interiors and pattern matches for continuous wall and double-height installations.

The collection has won numerous international design awards including; The Designer Award for Innovation in Material Product Design, the Dezeen Award for Workplace Design, the FX Design Award for Best Surface, the Architizer Award for A+ Products and an INDE Award.

The uniqueness of the design was observed instantly by the Dezeen Awards judges who said that "in this instance, there was an attempt to define the space in sculptural terms and also give the product tactility". The Dezeen Awards received more than 4,300 entries, from 85 countries across 5 continents.

\*Aluminium panel trims are available for the 9mm Embossed panel collection in Onyx and Silver Anodised finishes. T-joiners hide panel-to-panel joins, while Edge trims neatly cover panel edges.



## EMBOSSSED PANEL COLLECTION

## PICO



**PANEL DIMENSIONS** 2800mm (+/-3mm) x 1130mm (+/-3mm) | 110.24" (+/-0.12") x 44.49" (+/-0.12")

**PANEL THICKNESS** 9mm (+/-7%) | 0.35" (+/-7%)

**SOUND ABSORPTION** AS ISO 354: 2006 (R2016) - direct fix results

$\alpha_w$	0.20 (H)
NRC	0.30
SAA	0.28
Class	E

For additional specifications and performance details please visit [wovenimage.com](http://wovenimage.com) **HERE**

## EMBOSSED PANEL COLLECTION

## ZEN



501 Chalk

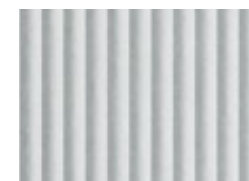

101 Frost



908 Cream



454 Mushroom



468 Vanilla

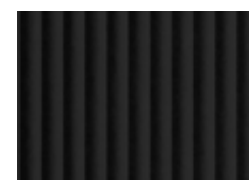

550 Onyx



447 Slate

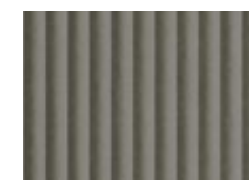

402 Pebble



580 Sage



274 Orchid

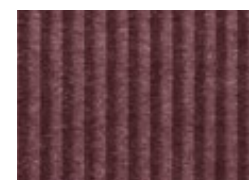

269 Wine

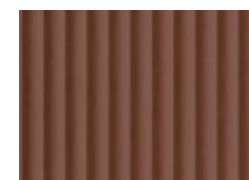

484 Cayenne

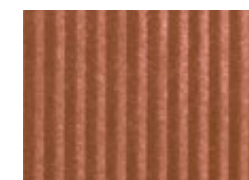

167 Cinnamon



487 Blush

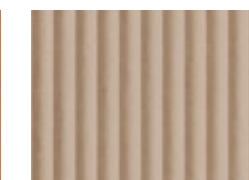

495 Dusk

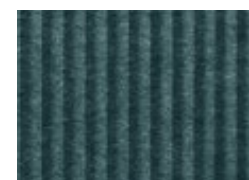

330 Ivy

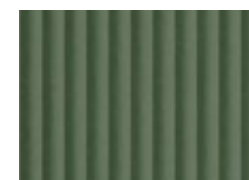

349 Vineyard

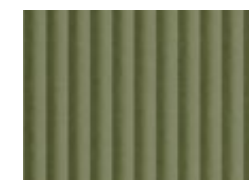

384 Olive



721 Nutmeg



124 Ochre

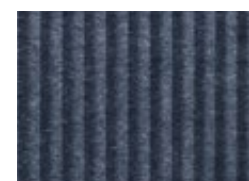

365 Navy



660 Coronet



551 Duck Egg



573 Mint



106 Butter

**PANEL DIMENSIONS** 2800mm (+/-3mm) x 1130mm (+/-3mm) | 110.24" (+/-0.12") x 44.49" (+/-0.12")

**PANEL THICKNESS** 9mm (+/-7%) | 0.35" (+/-7%)

**SOUND ABSORPTION** AS ISO 354: 2006 (R2016) - direct fix results

$\alpha_w$	0.20 (H)
NRC	0.30
SAA	0.28
Class	E

For additional specifications and performance details please visit [wovenimage.com](http://wovenimage.com) **HERE**

## EMBOSSSED PANEL COLLECTION

## ION



101 Frost



908 Cream

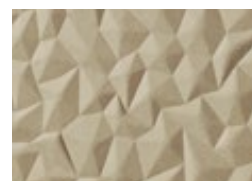

468 Vanilla



402 Pebble



580 Sage

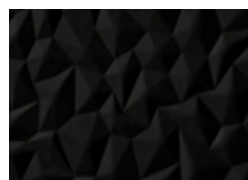

550 Onyx

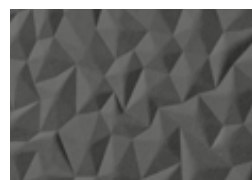

447 Slate



274 Orchid

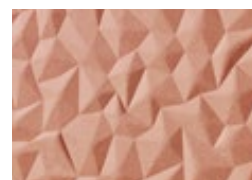

487 Blush

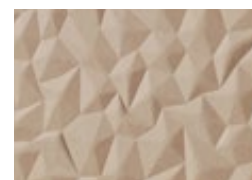

495 Dusk

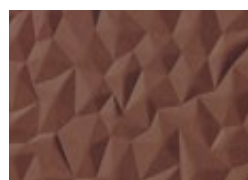

484 Cayenne



167 Cinnamon

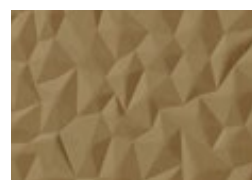

721 Nutmeg



124 Ochre



106 Butter

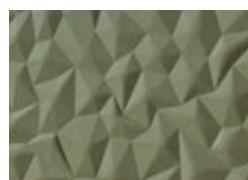

384 Olive



349 Vineyard



660 Coronet



551 Duck Egg



573 Mint

## PANEL DIMENSIONS

2800mm (+/-3mm) x 1130mm (+/-3mm) | 110.24" (+/-0.12") x 44.49" (+/-0.12")

## PANEL THICKNESS

9mm (+/-7%) | 0.35" (+/-7%)

## SOUND ABSORPTION

AS ISO 354: 2006 (R2016) - direct fix results

 $\alpha_w$  0.20 (H)

NRC 0.30

SAA 0.28

Class E

For additional specifications and performance details please visit [wovenimage.com](http://wovenimage.com) **HERE**

## EMBOSSSED PANEL COLLECTION

## G E M



101 Frost

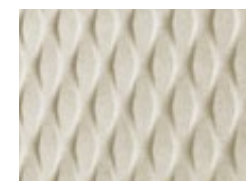

908 Cream



468 Vanilla



402 Pebble



580 Sage

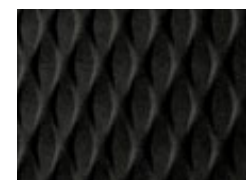

550 Onyx

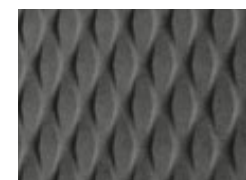

447 Slate



274 Orchid

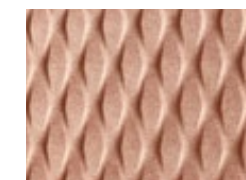

487 Blush

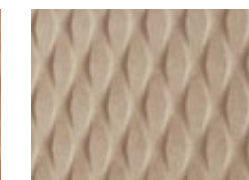

495 Dusk

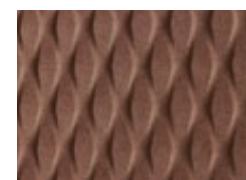

484 Cayenne



167

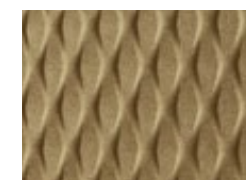

721 Nutmeg



124 Ochre



106 Butter

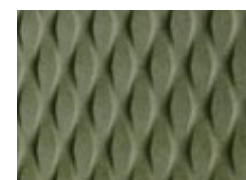

384 Olive



349 Vineyard

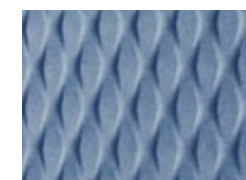

660 Coronet

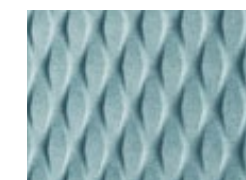

551 Duck Egg

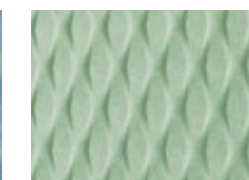

573 Mint

**PANEL DIMENSIONS** 2800mm (+/-3mm) x 1130mm (+/-3mm) | 110.24" (+/-0.12") x 44.49" (+/-0.12")

**PANEL THICKNESS** 9mm (+/-7%) | 0.35" (+/-7%)

**SOUND ABSORPTION** AS ISO 354: 2006 (R2016) - direct fix results

$\alpha_w$  0.20 (H)

NRC 0.30

SAA 0.28

Class E

For additional specifications and performance details please visit [wovenimage.com](http://wovenimage.com) **HERE**

## EMBOSSSED PANEL COLLECTION

## UMI

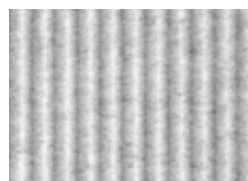

501 Chalk



101 Frost

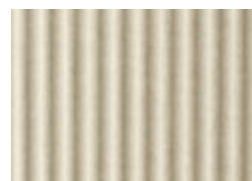

908 Cream



454 Mushroom

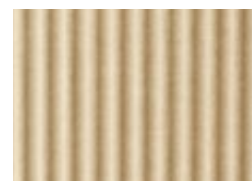

468 Vanilla

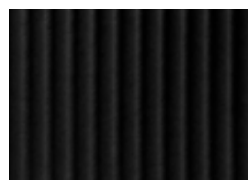

550 Onyx

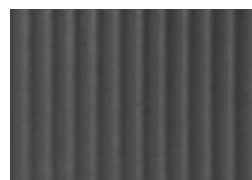

447 Slate

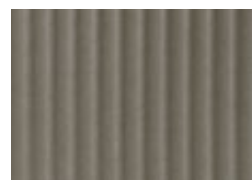

402 Pebble

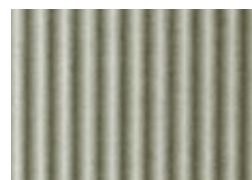

580 Sage

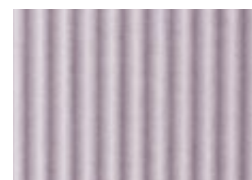

274 Orchid

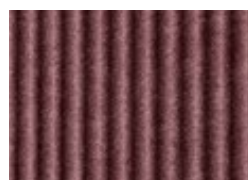

269 Wine

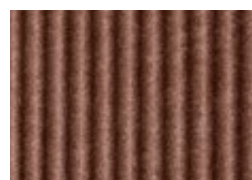

484 Cayenne



167 Cinnamon



487 Blush

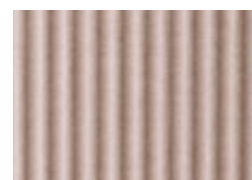

495 Dusk



330 Ivy



349 Vineyard

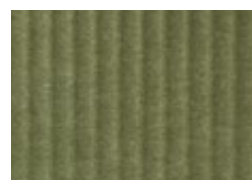

384 Olive



721 Nutmeg



124 Ochre



365 Navy

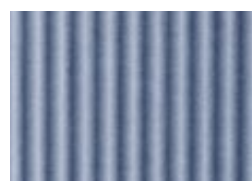

660 Coronet

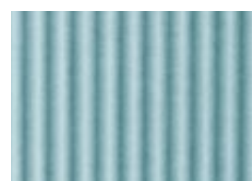

551 Duck Egg



573 Mint



106 Butter

**PANEL DIMENSIONS** 2800mm (+/-3mm) x 1130mm (+/-3mm) | 110.24" (+/-0.12") x 44.49" (+/-0.12")

**PANEL THICKNESS** 9mm (+/-7%) | 0.35" (+/-7%)

**SOUND ABSORPTION** AS ISO 354: 2006 (R2016) - direct fix results

$\alpha_w$	0.20 (H)
NRC	0.30
SAA	0.28
Class	E

For additional specifications and performance details please visit [wovenimage.com](https://wovenimage.com) **HERE**

## EMBOSSED PANEL COLLECTION

## NALU

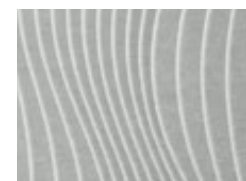

101 Frost

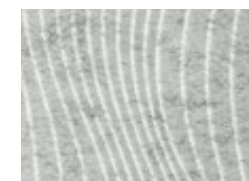

501 Chalk



454 Mushroom



908 Cream

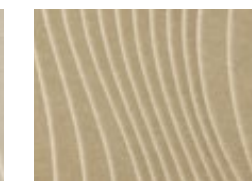

468 Vanilla

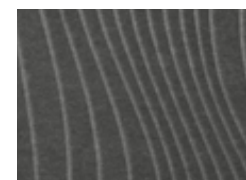

447 Slate

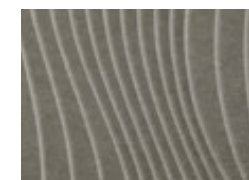

402 Pebble

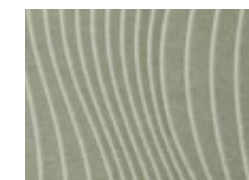

580 Sage

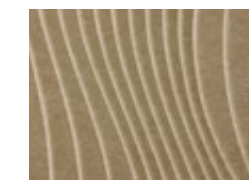

481 Latte



495 Dusk



484 Cayenne



167 Cinnamon

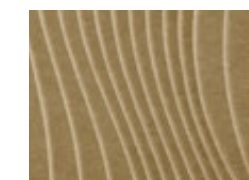

721 Nutmeg



124 Ochre



349 Vineyard



330 Ivy



365 Navy



660 Coronet

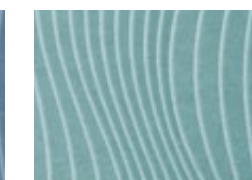

551 Duck Egg

**PANEL DIMENSIONS** 2800mm (+/-3mm) x 1130mm (+/-3mm) | 110.24" (+/-0.12") x 44.49" (+/-0.12")

**PANEL THICKNESS** 9mm (+/-7%) | 0.35" (+/-7%)

**SOUND ABSORPTION** AS ISO 354: 2006 (R2016) - direct fix results

$\alpha_w$  0.20 (H)

NRC 0.30

SAA 0.28

Class E

For additional specifications and performance details please visit [wovenimage.com](https://wovenimage.com) **HERE**



9mm Edge trim & T-joiner in Black & Anodised Silver\*



# 3D FORMED PANEL COLLECTION

COLUMN ..... 78

CURTAIN ..... 80

Commercial interiors are elevated to new levels of comfort, class and sophistication with Column and Curtain - 2.8m high, floor-to-ceiling 3D formed acoustic panels containing over 50% post-consumer recycled PET. Designed for seamless installation without a floor-to-ceiling join.

Column draws inspiration from classical architecture, with its undulating, symmetrical rhythm and a depth of approximately 70mm. The wave-like peaks and troughs, combined with non-woven raw materials, capture airgaps in a direct-fix wall application to create a distinct sound absorption zone. Curtain, its asymmetrical counterpart, takes on a more fluid, free-form appearance — a contemporary acoustic 'curtain effect' where the non-woven materials appear to ebb and flow across a three-dimensional form, also designed with an airgap for enhanced acoustic performance.

Together, Column and Curtain deliver a unique visual and tactile experience, balancing aesthetic appeal, acoustic efficiency and sustainability — a combination that earned them the SBID International Design Award for Surfaces & Finishes.

\*Aluminium panel trims are available for the 9mm 3D Formed panel collection in Onyx and Silver Anodised finishes. T-joiners hide panel-to-panel joins, while Edge trims neatly cover panel edges.



## 3D FORMED PANEL COLLECTION

## COLUMN



101 Frost



908 Cream



454 Mushroom



495 Dusk



365 Navy

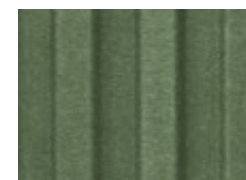

349 Vineyard



721 Nutmeg



573 Mint



COLUMN in colour 454

**PANEL DIMENSIONS**

2800mm (+/-5mm) x 995mm (+10/-5mm) x 70mm (+/-5mm)  
110.24" (/ -0.2") x 39.17" (+0.39/-0.2") x 2.76" (+/-0.2")

**PANEL THICKNESS**

9mm (+/-5mm) | 0.35" (+/-7%)

**SOUND ABSORPTION**

AS ISO 354: 2006 (R2016) - direct fix results

α <sub>w</sub>	0.65 (H)
NRC	0.65
SAA	0.67
Class	C

For additional specifications and performance details please visit [wovenimage.com](https://wovenimage.com) **HERE**

## 3D FORMED PANEL COLLECTION

## CURTAIN

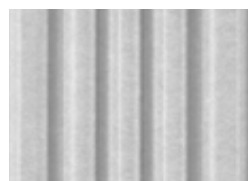

101 Frost



908 Cream



454 Mushroom



495 Dusk



365 Navy



349 Vineyard



721 Nutmeg



573 Mint



CURTAIN in colour 349

## PANEL DIMENSIONS

2800mm (+/-5mm) x 975mm (+10/-5mm) x 45mm (+/-5mm)  
110.24" (/ -0.2") x 38.39" (+0.39/-0.2") x 1.77" (+/-0.2")

## PANEL THICKNESS

9mm (+/-7%) | 0.35" (+/-7%)

## SOUND ABSORPTION

AS ISO 354: 2006 (R2016) - direct fix results

α <sub>w</sub>	0.50 (H)
NRC	0.60
SAA	0.60
Class	D

For additional specifications and performance details please visit [wovenimage.com](https://wovenimage.com) **HERE**



CURTAIN in colour 908

# ACOUSTIC TILE COLLECTION

BALANCE .....	84
ASCENT .....	86
DUNE .....	88
WAVE .....	90

Whether your interiors project requires large scale coverage or to create smaller design features, this range provides an endless stream of design configurations that provide great aesthetics whilst controlling reverberated noise in;

- Collaborative workspaces and meeting rooms
- Classrooms and music rooms
- Cafés and restaurants
- Lobbies and public spaces

They are lightweight, easy to install, and pattern match without the need for trimming.

Tiles in this collection are made from EchoPanel® or Mura, which achieve first-rate environmental certifications.



## ACOUSTIC TILE COLLECTION

## BALANCE

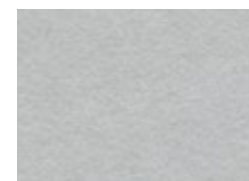

101 Frost

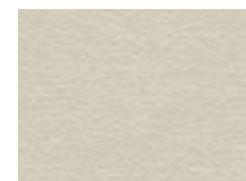

908 Cream



454 Mushroom

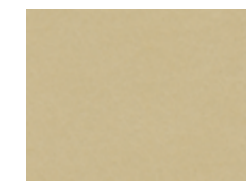

468 Vanilla

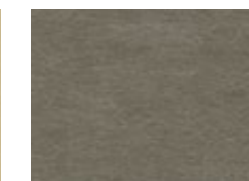

402 Pebble



442 Grey



542 Charcoal



550 Onyx

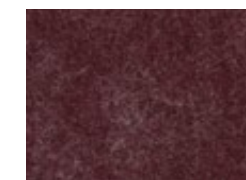

269 Wine

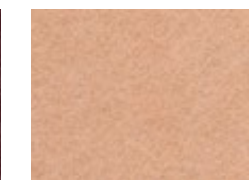

487 Blush



384 Olive



330 Ivy



365 Navy



633 Pacific

## PRODUCT NAME

**BALANCE 670**  
**BALANCE 1340**

## TILE THICKNESS

**12mm (+/-7%) | 0.47" (+/-7%)**

## SOUND ABSORPTION

AS ISO 354: 2006 (R2016)  
- direct fix results  
 $\alpha_w$  0.45 (MH)  
NRC 0.65  
SAA 0.63  
Class D

## BOX COMPONENTS

**BALANCE 670** - 12 x tiles  
**BALANCE 1340** - 6 x tiles

## BALANCE 670

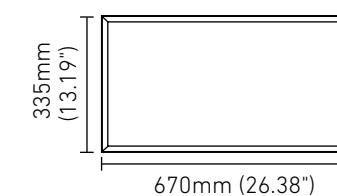

## BALANCE 1340

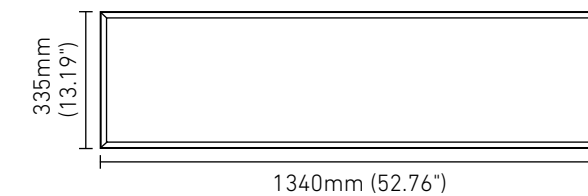

For additional specifications and performance details please visit [wovenimage.com](http://wovenimage.com) **HERE**



ACOUSTIC TILE COLLECTION

# ASCENT



501 Chalk

101 Frost

454 Mushroom

908 Cream

402 Pebble

447 Slate

542 Charcoal

269 Wine

274 Orchid

487 Blush

167 Cinnamon

124 Ochre

349 Vineyard

330 Ivy

551 Duck Egg

660 Coronet

365 Navy

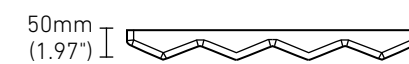

500mm (19.68")

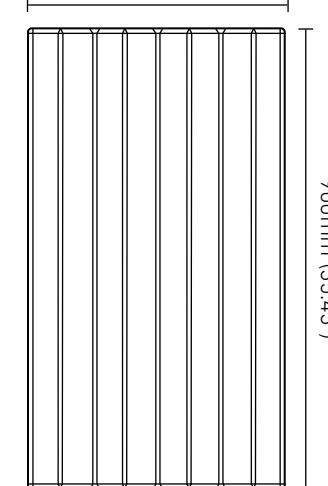

**TILE DIMENSIONS**

500mm (+/-5mm) x 900mm (+/-5mm) x 50mm (+/-5mm)  
 19.68" (+/-0.2") x 35.43" (+/-0.2") x 1.97" (+/-0.2")

**TILE THICKNESS**

**4mm** (+/-0.5mm) | 0.16" (+/-0.02")  
 measured 10mm (0.39") above trimmed edge

**SOUND ABSORPTION**

AS ISO 354: 2006 (R2016) - direct fix results  
 αw 0.60 (MH)  
 NRC 0.70  
 SAA 0.66  
 Class C

**BOX COMPONENTS**

6 x tiles, 16 x installation clips

For additional specifications and performance details please visit [wovenimage.com](http://wovenimage.com) **HERE**

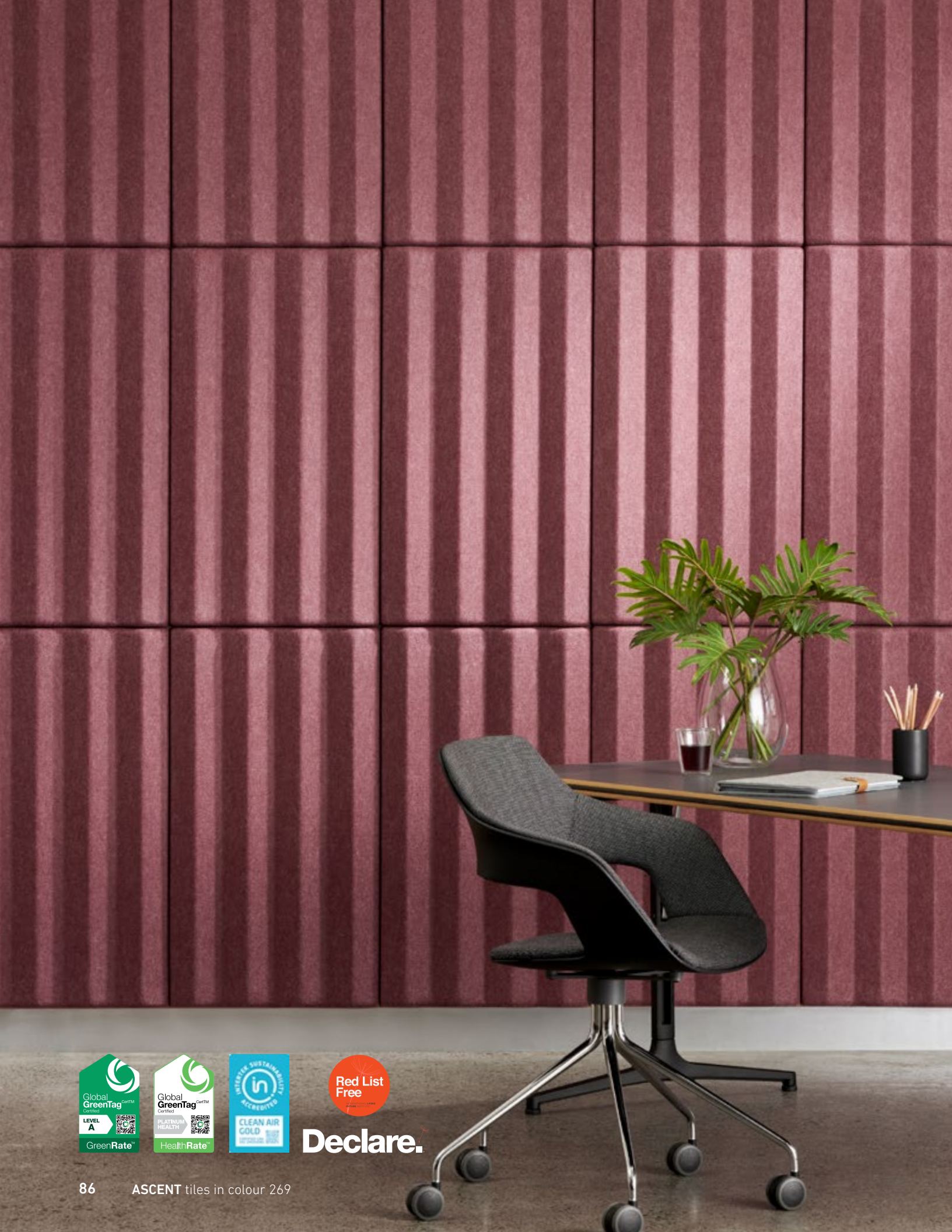

ACOUSTIC TILE COLLECTION

# DUNE



908 Cream

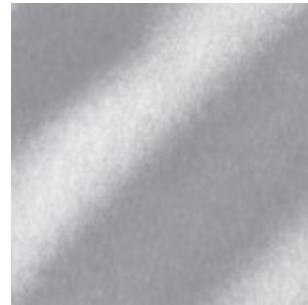

101 Frost

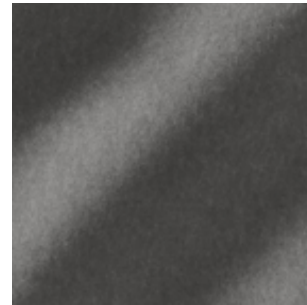

447 Slate

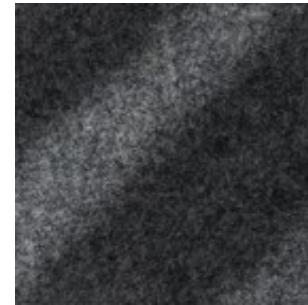

542 Charcoal

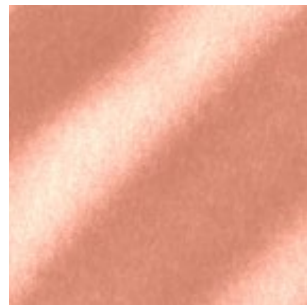

487 Blush



269 Wine

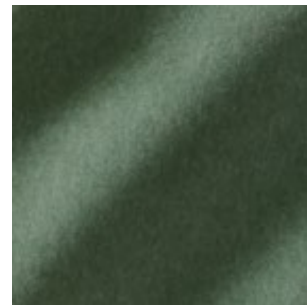

349 Vineyard



660 Coronet

**TILE DIMENSIONS**

500mm (+/-5mm) x 500mm (+/-5mm) x 50mm (+/-5mm)  
19.69" (+/-0.2") x 19.69" (+/-0.2") x 1.97" (+/-0.2")

**TILE THICKNESS**

4mm (+/-0.5mm) | 0.16" (+/-0.02") - measured 0.39" (10mm) above trimmed edge

**SOUND ABSORPTION**

AS ISO 354: 2006 (R2016) - direct fix results

$\alpha_w$  0.50 (MH)  
NRC 0.60  
SAA 0.58  
Class D

**BOX COMPONENTS**

9 x tiles, 16 x installation clips

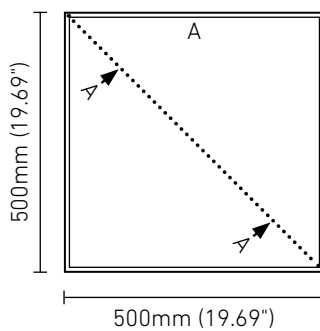

For additional specifications and performance details please visit [wovenimage.com](http://wovenimage.com) **HERE**





## ACOUSTIC TILE COLLECTION

# WAVE



908 Cream



101 Frost



447 Slate



542 Charcoal



487 Blush

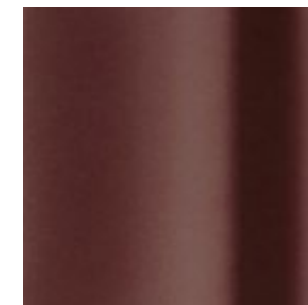

269 Wine



349 Vineyard



660 Coronet

### TILE DIMENSIONS

500mm (+/-5mm) x 500mm (+/-5mm) x 62.5mm (+/-5mm)  
19.69" (+/-0.2") x 19.69" (+/-0.2") x 2.46" (+/-0.2")

### TILE THICKNESS

4mm (+/-0.5mm) | 0.16" (+/-0.02") - measured 0.39" (10mm) above trimmed edge

### SOUND ABSORPTION

AS ISO 354: 2006 (R2016) - direct fix results

α <sub>w</sub>	0.50 (MH)
NRC	0.60
SAA	0.58
Class	D

### BOX COMPONENTS

9 x tiles, 16 x installation clips

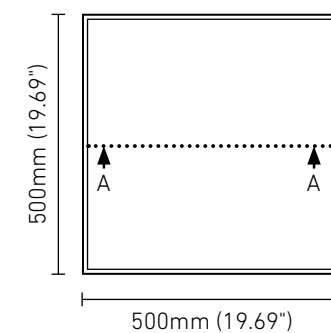

For additional specifications and performance details please visit [wovenimage.com](https://wovenimage.com) **HERE**

ACOUSTIC FABRIC

FOCUS CHAIN



FOCUS CHAIN in colours 300 & 908

ACOUSTIC FABRIC

FOCUS WAVE



FOCUS WAVE in colour 172

<b>WIDTH</b>	137cm   53.94"	
<b>PATTERN REPEAT</b>	<b>FOCUS CHAIN</b>	Horizontal 19cm (7.48"), Vertical 19.5cm (7.68")
	<b>FOCUS WAVE</b>	Horizontal 2.5cm (0.98"), Vertical 11cm (4.33")
<b>SOUND ABSORPTION</b>	AS ISO 354: 2006 (R2016) - direct fix results	
	$\alpha_w$	0.20 (H)
	NRC Value	0.30
	SAA	0.29

For additional specifications and performance details please visit [wovenimage.com](http://wovenimage.com) **HERE**

ACOUSTIC COLLECTION

PRINT DESIGNS

Shown here are a small selection of our printed EchoPanel® designs. These can be printed single or double-sided, making them suitable for walls, ceilings and partitions.

Woven Image has a long history of working with global design and manufacturing clients to deliver unique customised prints. Contact us to discuss your project requirements.



Otto Frequency Trapeze Trio Astro Kaleidoscope

MICHAEL YOUNG COLLECTION *Michael Young*

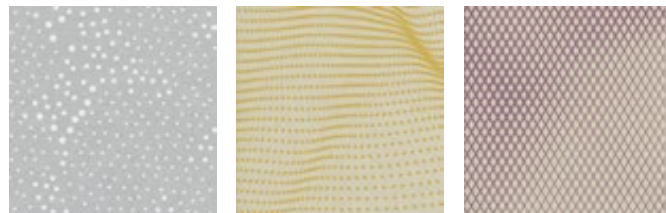

Cloudy Fluid Mineral

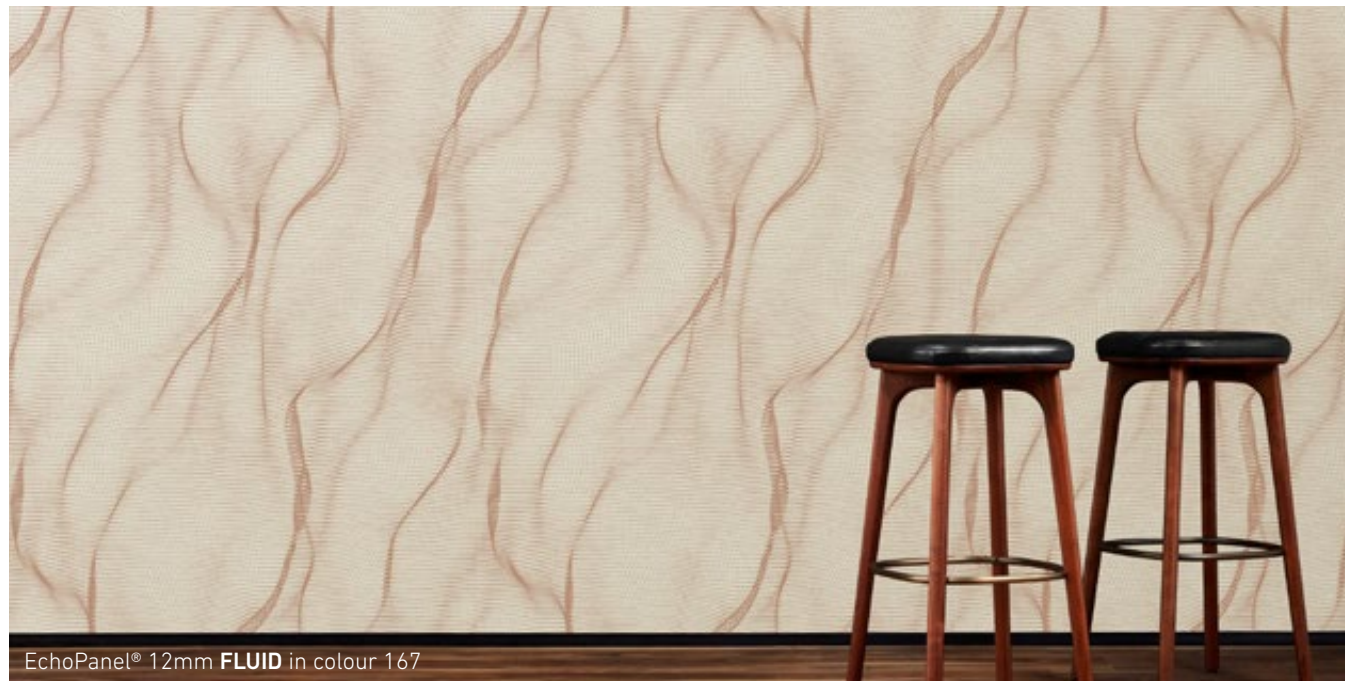

EchoPanel® 12mm **FLUID** in colour 167

For additional specifications and performance details please visit [wovenimage.com](http://wovenimage.com) **HERE**



EchoPanel® 12mm **TRAPEZE** in colour 365

# PRINT DESIGNS

The Ben Goss collection is a printed acoustic range that seamlessly unites expressive art with functional design. Created in collaboration with Australian artist, illustrator, and designer Ben Goss, the collection is derived from a richly layered painting and translates botanical forms, layered colour, and expressive brushwork into a striking mural and four complementary designs, digitally printed onto EchoPanel®.

## BEN GOSS COLLECTION *GOSS*

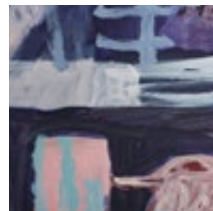

Kookaburra



Canopy

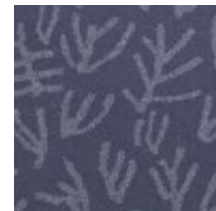

Dapple



Sprig



Starview



EchoPanel® 12mm **KOOKABURRA** in colour 366



EchoPanel® 12mm **SPRIG** in colour 350



EchoPanel® 12mm **DAPPLE** in colour 366



EchoPanel® 12mm **CANOPY** in colour 621



EchoPanel® 12mm **STARVIEW** in colour 580

For additional specifications and performance details please visit [wovenimage.com](http://wovenimage.com) **HERE**

