

# Array 12mm

**Designer:** Woven Image

**Application(s):** Ceilings

## Composition & Pattern

<b>Composition</b>	EchoPanel Baffles 100% PET (60%-80% post-consumer recycled PET)*
<b>Hardware Composition</b>	100% Powder coated Aluminium Alloy 6060
<b>Colours Available</b>	34
<b>Additional Information</b>	*As part of our ongoing commitment to sustainability, we are increasing the amount of post-consumer PET in EchoPanel 12mm, from 60% to 80%. We anticipate all stock to have transitioned by January 2025.

## Kit & Box Content

<b>Box Contents</b>	Acoustic baffles plus hardware. Baffle quantities vary depending on design
---------------------	--

## Dimensions & Weight

<b>Dimensions</b>	Hardware and baffle dimensions will vary per design, see drawing on spec.
<b>Unit of Sale</b>	Box
<b>Unit of Sale Net Weight (kg)</b>	21

## Performance

<b>Fire Test Result</b>	ISO 9705: Group 1, BS EN 13501.1: Classification B - s1, d0, ASTM E84 Unadhered: Class 1 or A, BS EN 45545-2 + A1 Annex C: CIT: 0.05, AS 1530.3, GB 8624 B1
<b>Acoustic Performance Standard Test Method</b>	AS ISO 354: 2006 (R2016), AS ISO 11654: 2002 (2016), ASTM C423 - 17
<b>Noise Reduction Coefficient (NRC) Result</b>	Direct fix: 0.70
<b>Sound Absorption Average (SAA) Result</b>	Direct fix: 0.68
<b>Weighted Sound Absorption Coefficient (<math>\alpha_w</math>) Result</b>	Direct fix: 0.65(H)
<b>Sound Absorption Class</b>	C (Direct fix)
<b>Equivalent Absorption Area (<math>A_{eq}</math>) in <math>m^2</math> Sabins</b>	Direct fix: 125Hz = 0.14m <sup>2</sup> , 250Hz = 0.39m <sup>2</sup> , 500Hz = 0.42m <sup>2</sup> , 1000Hz = 0.53m <sup>2</sup> , 2000Hz = 0.72m <sup>2</sup> , and 4000Hz = 0.77m <sup>2</sup>
<b>Additional Acoustic Information</b>	Baffles tested were 2400mm x 300mm x 12mm, at 300mm spacing/centres. H = High Frequency
<b>Colour Fastness to Light Standard Test Method</b>	ISO 105 B02
<b>Colour Fastness Light Rating</b>	6 - 7
<b>Light Reflectance Standard Test Method</b>	ASTM E1477

## Sustainability

<b>VOC Emissions Results</b>	EchoPanel 12mm achieves ASTM D5116 - 2017: TVOC Emissions Rate: 0.033mg/m <sup>2</sup> /hr (24hrs); Formaldehyde Emissions Rate: 0.07mg/m <sup>2</sup> /hr. CDPH Standard Method v1.2 - 2017 (CA 01350): TVOC Emissions Rate: 0.013mg/m <sup>3</sup> ; Formaldehyde Emissions Rate: <1µg/m <sup>3</sup>
------------------------------	---

## Sustainability Performance



### Sustainability Performance Details

EchoPanel achieves GreenTag Certification GreenRate: Level A & Health Rate Platinum, Red List Free, and has an International Living Future Institute Declare Label. Array Baffles meet the sound reducing ceiling treatment requirements to attract points under feature S04 of WELL™ Standard v2.

## Instructions

### Additional Information

See Woven Image EchoPanel Care & Cleaning Guide.  
See Woven Image Array Installation Guide.

Exact colour matching cannot be guaranteed between batches. Fibre mix and web variation are natural characteristics of this product.

# ARRAY ACOUSTIC CEILING SYSTEM (AACS)

## OVERVIEW



The Array Acoustic Ceiling System (AACS) is a fully scalable acoustic ceiling system that accommodates 12mm & 24mm EchoPanel® baffles. It features streamlined aluminium hardware that has been engineered for easy installation, and can be used in both ceiling or wall applications. Below hardware all sold separately.

## HARDWARE OVERVIEW

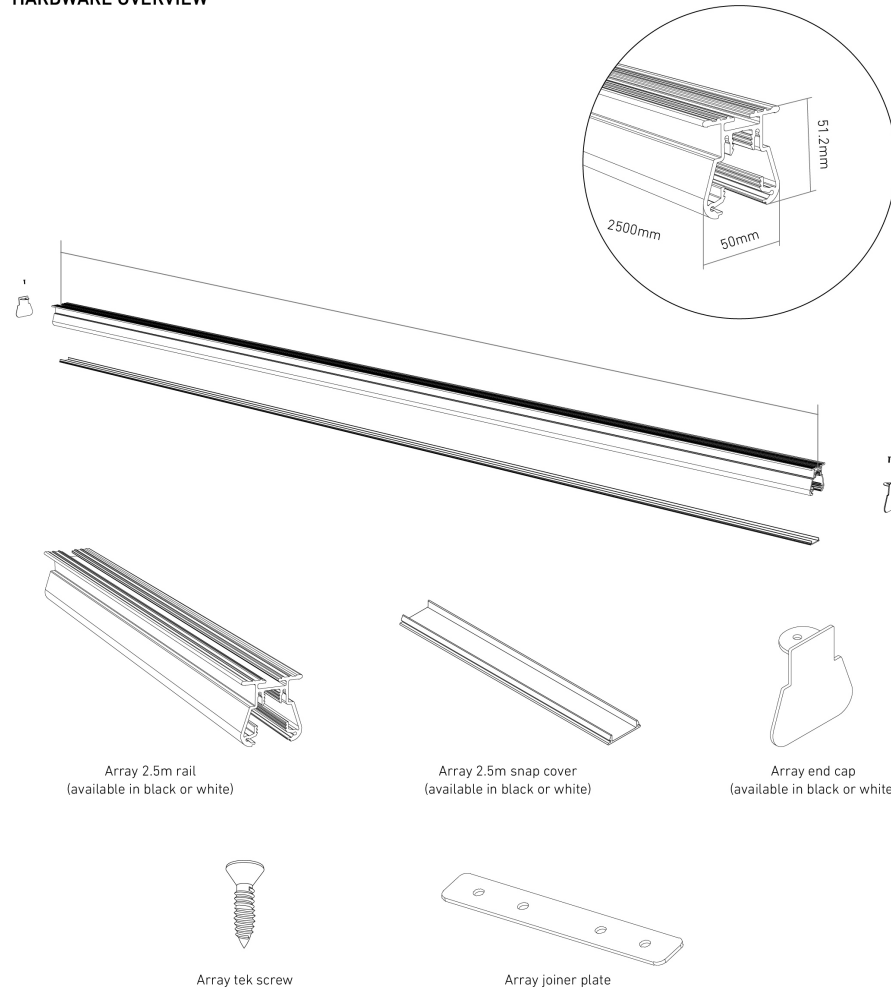

© Copyright Woven Image® Pty Ltd 2023, all rights reserved. This drawing may not be reproduced or transmitted in any form, or by any means in part or in whole, without the written permission of Woven Image® Pty Ltd

# BEAM 200

## ECHOPANEL® 12mm BAFFLE DESIGN



### STANDARD BAFFLE SIZE

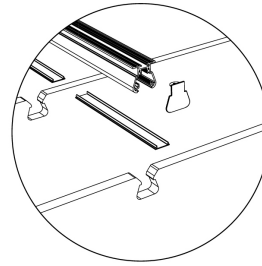
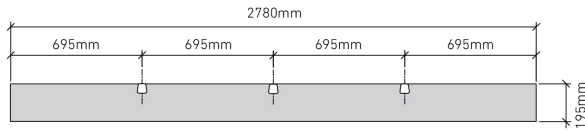

### CUSTOM LENGTHS ON REQUEST

(Maximum length 2780mm)

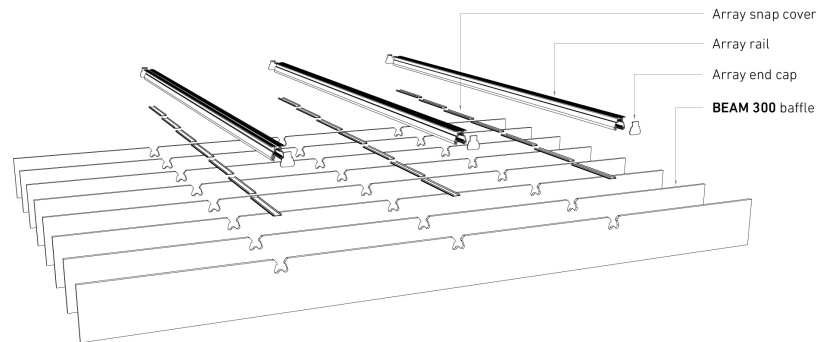
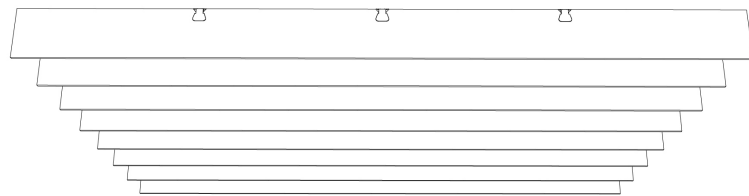
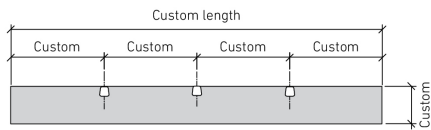

© Copyright Woven Image® Pty Ltd 2023, all rights reserved. This drawing may not be reproduced or transmitted in any form, or by any means in part or in whole, without the written permission of Woven Image® Pty Ltd

# BEAM 300

## ECHOPANEL® 12mm BAFFLE DESIGN



### STANDARD BAFFLE SIZE

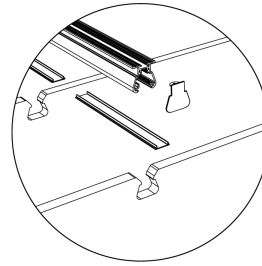
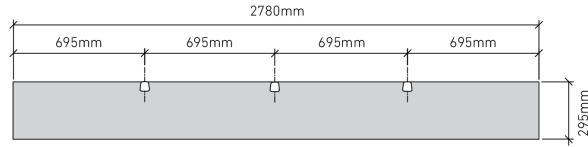

### CUSTOM LENGTHS ON REQUEST

(Maximum length 2780mm)

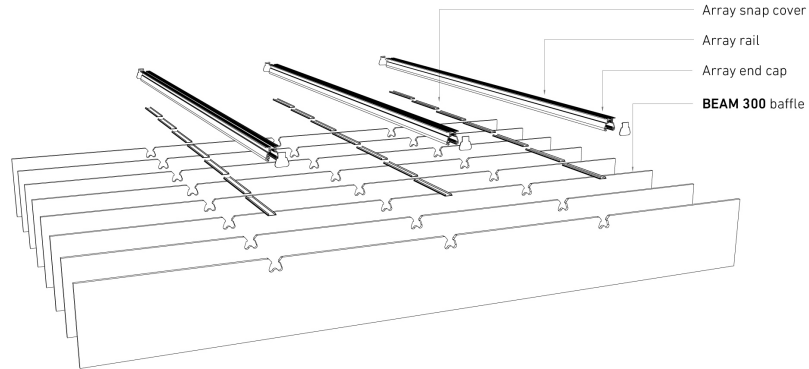
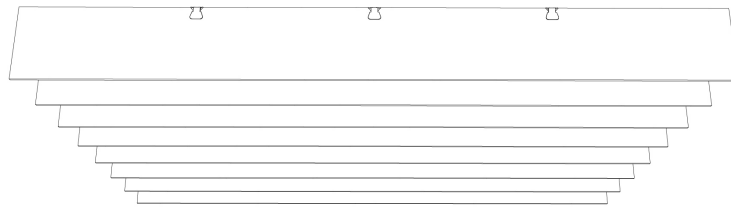
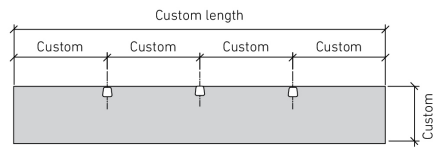

© Copyright Woven Image® Pty Ltd 2023, all rights reserved. This drawing may not be reproduced or transmitted in any form, or by any means in part or in whole, without the written permission of Woven Image® Pty Ltd

# CATHEDRAL

## ECHOPANEL® 12mm BAFFLE DESIGN



### STANDARD BAFFLE SIZE

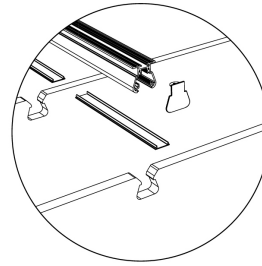
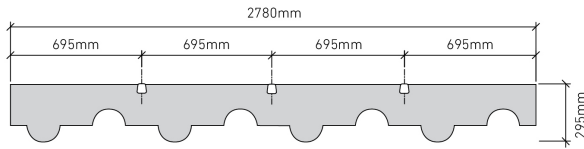

### CUSTOM LENGTHS ON REQUEST

(Maximum length 2780mm)

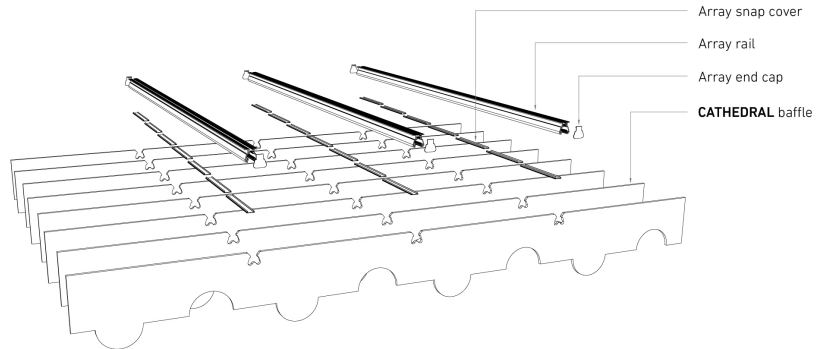
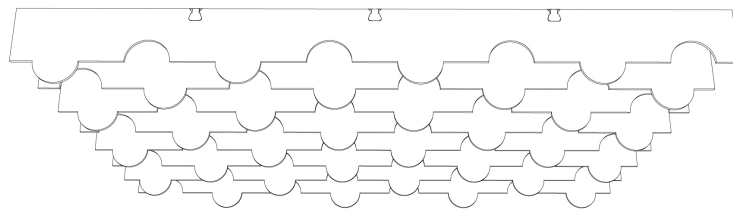
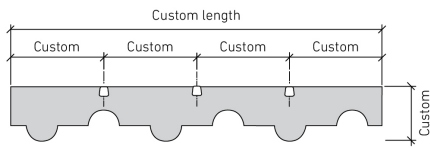

© Copyright Woven Image® Pty Ltd 2023, all rights reserved. This drawing may not be reproduced or transmitted in any form, or by any means in part or in whole, without the written permission of Woven Image® Pty Ltd

# FLOW

## ECHOPANEL® 12mm BAFFLE DESIGN



### STANDARD BAFFLE SIZE

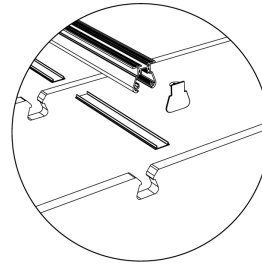
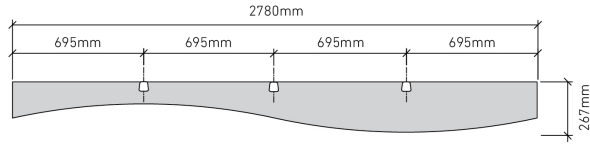

### CUSTOM LENGTHS ON REQUEST

(Maximum length 2780mm)

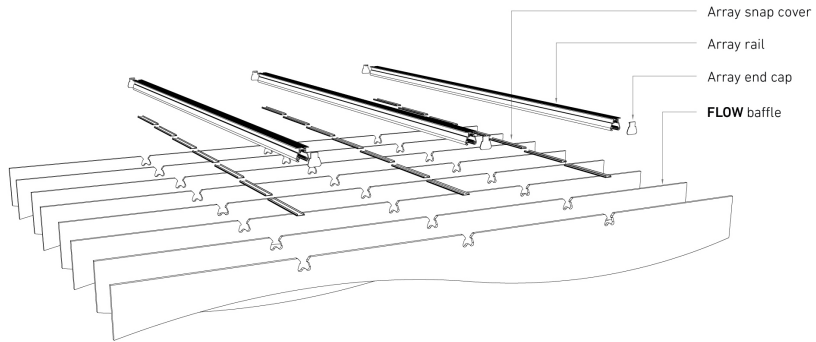
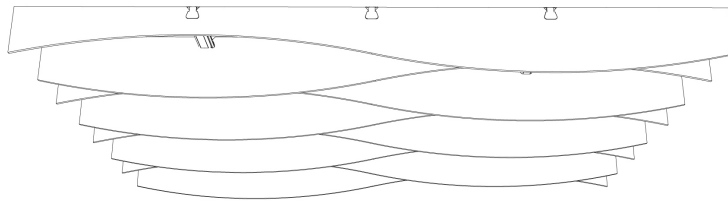
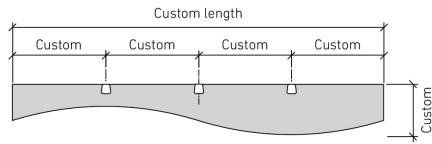

© Copyright Woven Image® Pty Ltd 2023, all rights reserved. This drawing may not be reproduced or transmitted in any form, or by any means in part or in whole, without the written permission of Woven Image® Pty Ltd



# TAPER

## ECHOPANEL® 12mm BAFFLE DESIGN



### STANDARD BAFFLE SIZE

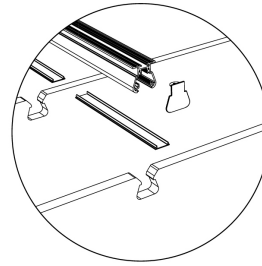
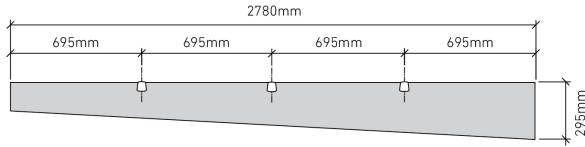

### CUSTOM LENGTHS ON REQUEST

(Maximum length 2780mm)

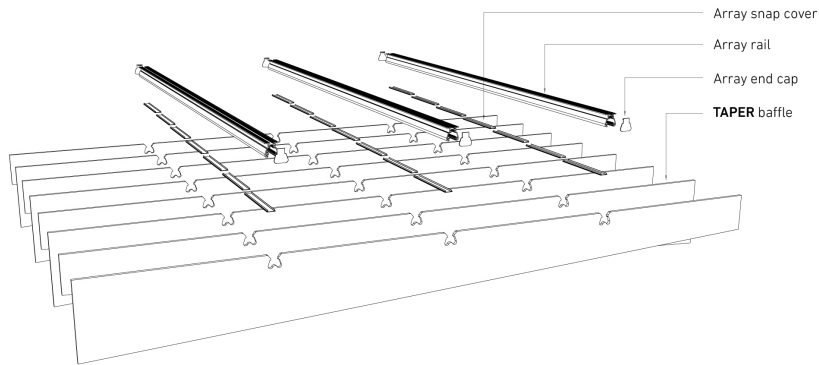
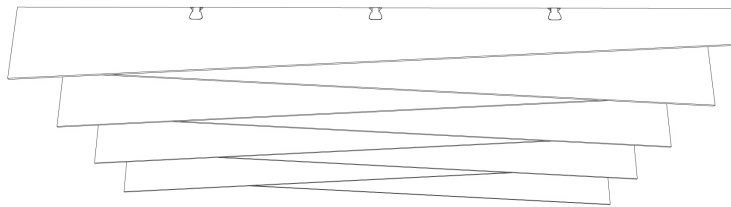
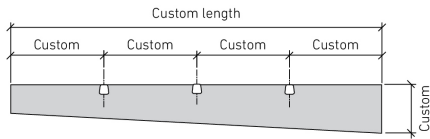

© Copyright Woven Image® Pty Ltd 2023, all rights reserved. This drawing may not be reproduced or transmitted in any form, or by any means in part or in whole, without the written permission of Woven Image® Pty Ltd

# TURRET

## ECHOPANEL® 12mm BAFFLE DESIGN



### STANDARD BAFFLE SIZE

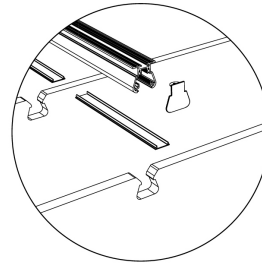
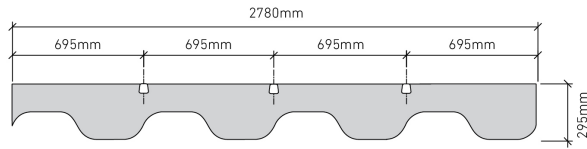

### CUSTOM LENGTHS ON REQUEST

(Maximum length 2780mm)

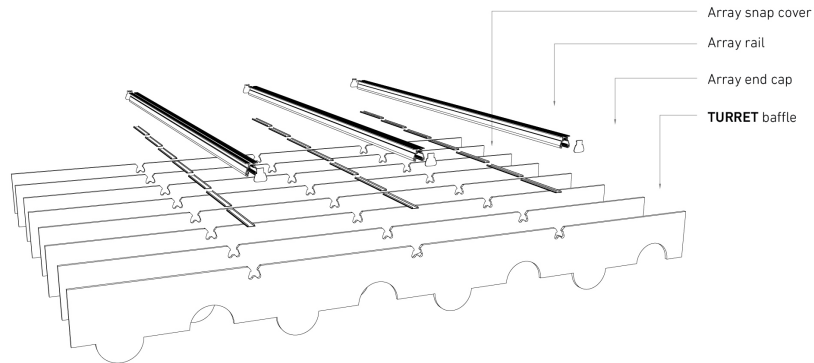
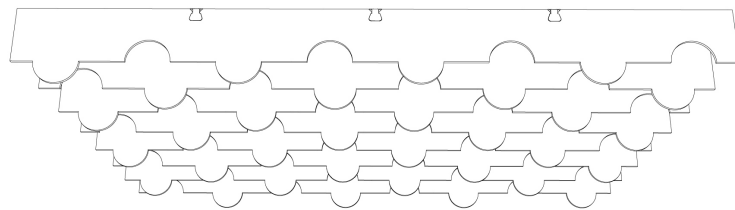
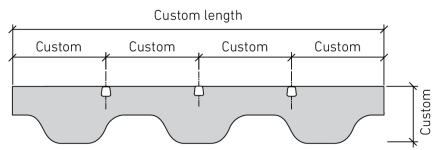

© Copyright Woven Image® Pty Ltd 2023, all rights reserved. This drawing may not be reproduced or transmitted in any form, or by any means in part or in whole, without the written permission of Woven Image® Pty Ltd

# VALLEY

## ECHOPANEL® 12mm BAFFLE DESIGN



### STANDARD BAFFLE SIZE

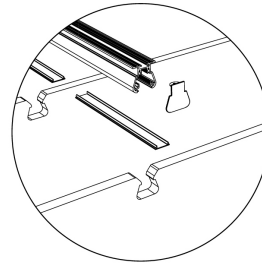
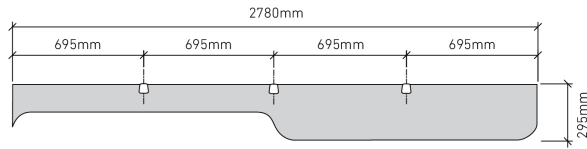

### CUSTOM LENGTHS ON REQUEST

(Maximum length 2780mm)

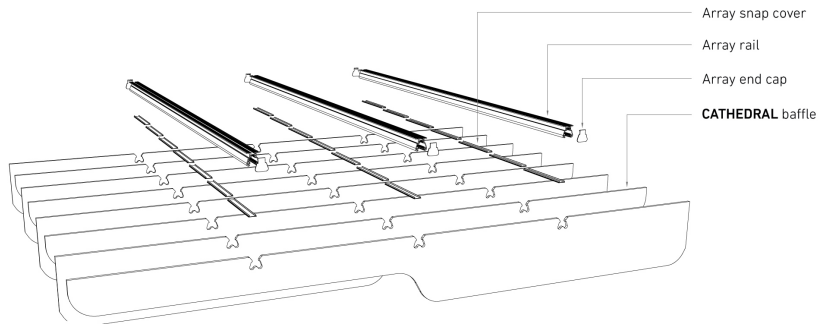
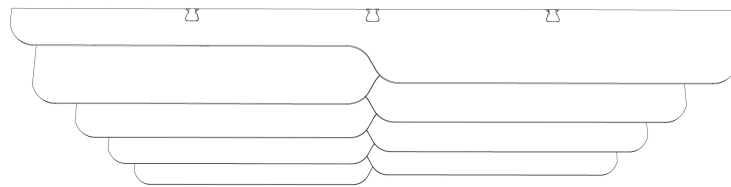
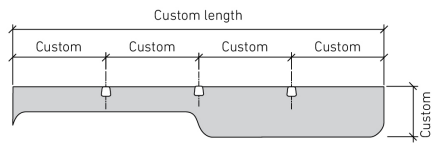

© Copyright Woven Image® Pty Ltd 2023, all rights reserved. This drawing may not be reproduced or transmitted in any form, or by any means in part or in whole, without the written permission of Woven Image® Pty Ltd

# VIADUCT

## ECHOPANEL® 12mm BAFFLE DESIGN



### STANDARD BAFFLE SIZE

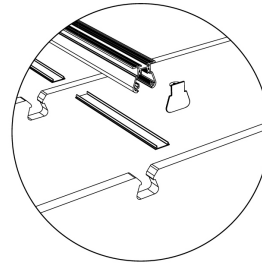
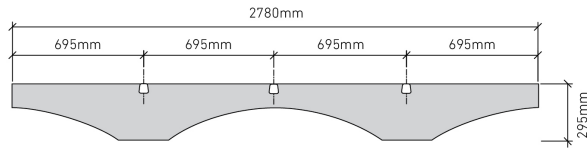

### CUSTOM LENGTHS ON REQUEST

(Maximum length 2780mm)

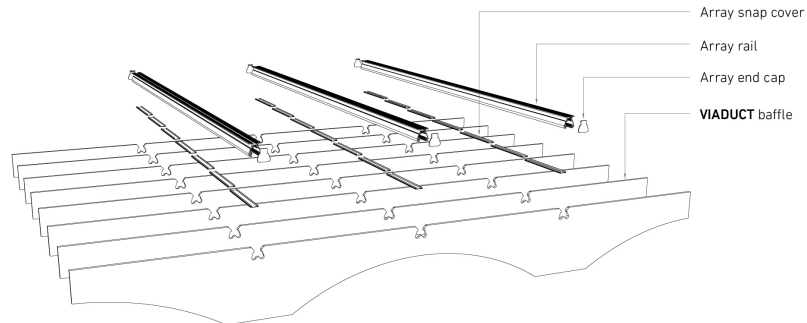
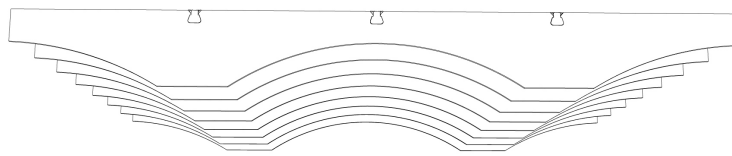
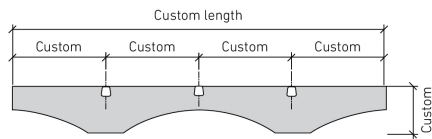

© Copyright Woven Image® Pty Ltd 2023, all rights reserved. This drawing may not be reproduced or transmitted in any form, or by any means in part or in whole, without the written permission of Woven Image® Pty Ltd

# WAVE

## ECHOPANEL® 12mm BAFFLE DESIGN



### STANDARD BAFFLE SIZE

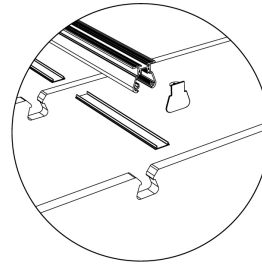
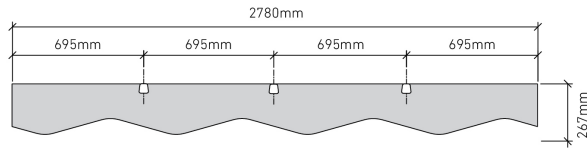

### CUSTOM LENGTHS ON REQUEST

(Maximum length 2780mm)

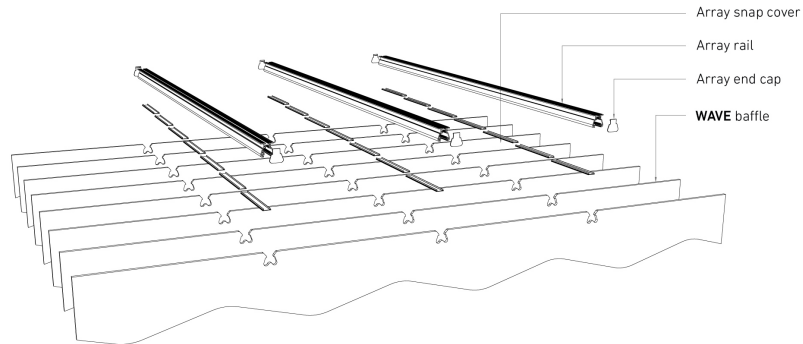
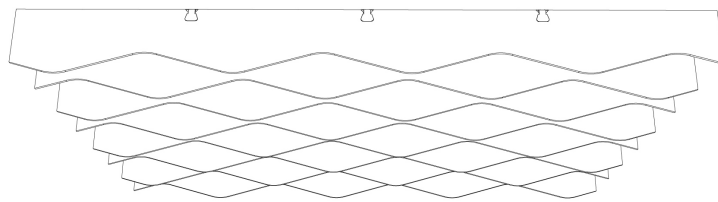
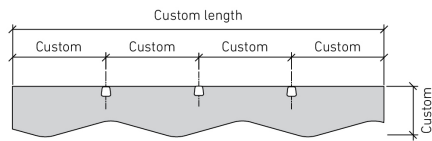

© Copyright Woven Image® Pty Ltd 2023, all rights reserved. This drawing may not be reproduced or transmitted in any form, or by any means in part or in whole, without the written permission of Woven Image® Pty Ltd

# WEDGE 200

## ECHOPANEL® 12mm BAFFLE DESIGN



### STANDARD BAFFLE SIZE

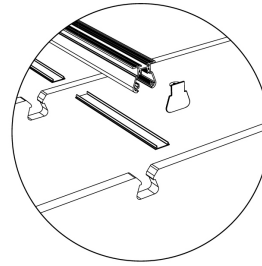
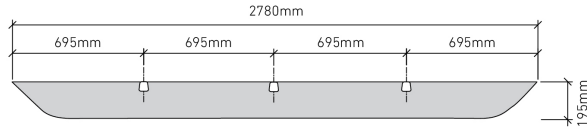

### CUSTOM LENGTHS ON REQUEST

(Maximum length 2780mm)

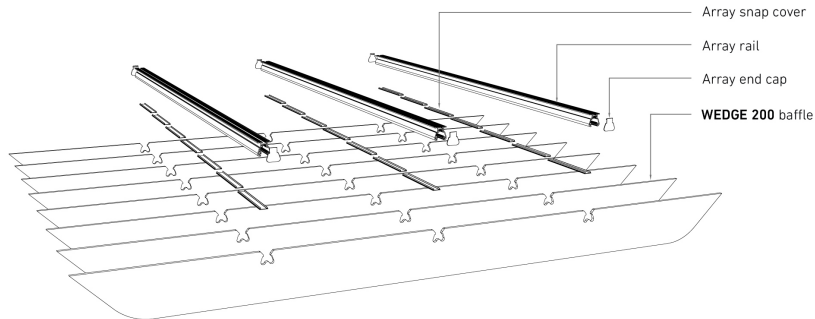
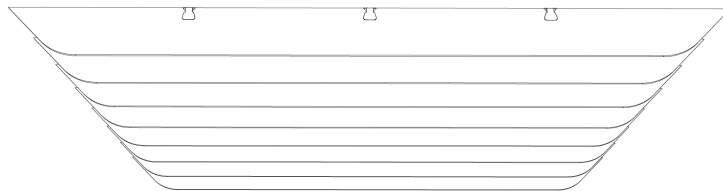
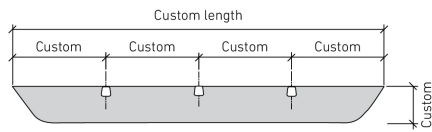

© Copyright Woven Image® Pty Ltd 2023, all rights reserved. This drawing may not be reproduced or transmitted in any form, or by any means in part or in whole, without the written permission of Woven Image® Pty Ltd

# WEDGE 300

## ECHOPANEL® 12mm BAFFLE DESIGN



### STANDARD BAFFLE SIZE

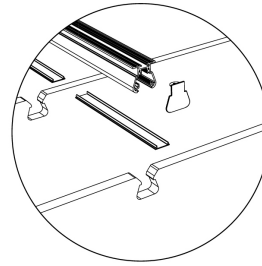
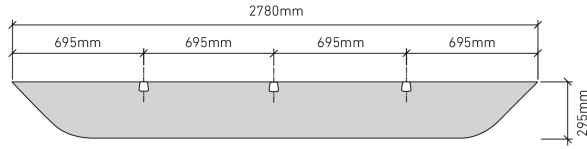

### CUSTOM LENGTHS ON REQUEST

(Maximum length 2780mm)

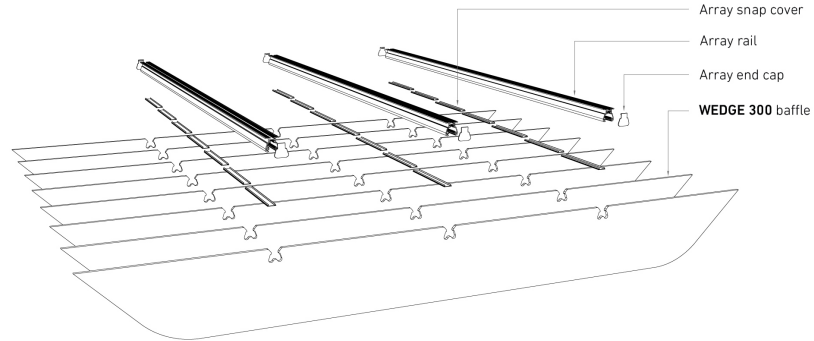
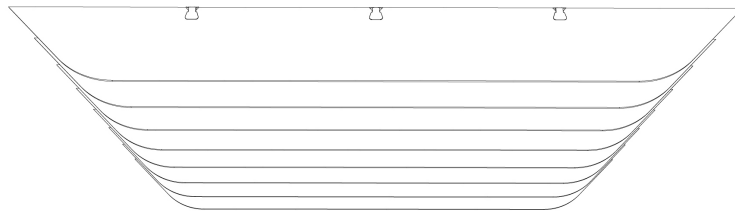
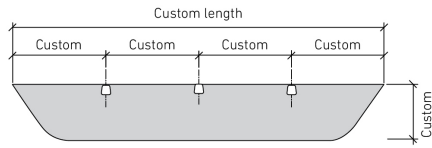

© Copyright Woven Image® Pty Ltd 2023, all rights reserved. This drawing may not be reproduced or transmitted in any form, or by any means in part or in whole, without the written permission of Woven Image® Pty Ltd