

ACOUSTIC COLLECTION



ACOUSTIC COLLECTION

WOVEN IMAGE STORY 02

ECHOPANEL® COLLECTION..... 04

CEILING COLLECTION..... 34

SPACE DIVIDING COLLECTION..... 46

MURA COLLECTION 54

ECHOFLEX COLLECTION 58

EMBOSSED PANEL COLLECTION..... 62

3D FORMED PANEL COLLECTION 74

ACOUSTIC TILE COLLECTION 80

ACOUSTIC FABRIC 90

PRINT DESIGNS 92



Cover image: EchoPanel® **ORB** in colour 495 & on arch, EchoPanel® **12mm** in colour 454

This image: **BALANCE 1340** tile in colour 365

Disclaimer Due different screen configurations, images may not represent the true colour. Always confirm your colour choice with your Woven Image Representative.

We recommend requesting a sample prior to ordering.

ACOUSTIC COLLECTION

WOVEN IMAGE STORY



Established in 1987, Woven Image is an international interior finishes company with sustainability and design leadership at its core.

From humble beginnings in Sydney, Woven Image now has offices throughout Australia as well as Singapore, Hong Kong and China, and a network of distributors and stockists across all major markets including Europe and the UK, Asia and the Middle East, and The Americas.

The product portfolio consists of acoustic finishes such as EchoPanel®, suitable for wall, ceiling and space dividing applications in interior spaces including workplace, hospitality, education and healthcare sectors.

OUR ENVIRONMENTAL STORY

The Woven Image portfolio has been designed with dematerialisation, upcycling and lifecycle management front of mind. All base materials in this collection utilise recycled or waste materials and printed designs use non-toxic inks with low VOCs.

Woven Image achieves first-class environmental certifications for its key products, including Carbon Neutral Certification by Climate Active, Global GreenTag™ certification (GreenRate Level A), with the maximum Product Health Declaration™ Platinum Health and an Environmental Product Declaration (EPD). As a result, specifying these products can secure credits under sustainable building tools including Leadership in Energy and Environmental Design (LEED v4.1), WELL™

Building Standard and Green Star. Woven Image is also a long-term supporter of Greenfleet

MANUFACTURING PROCESS OF ECHOPANEL® & MURA

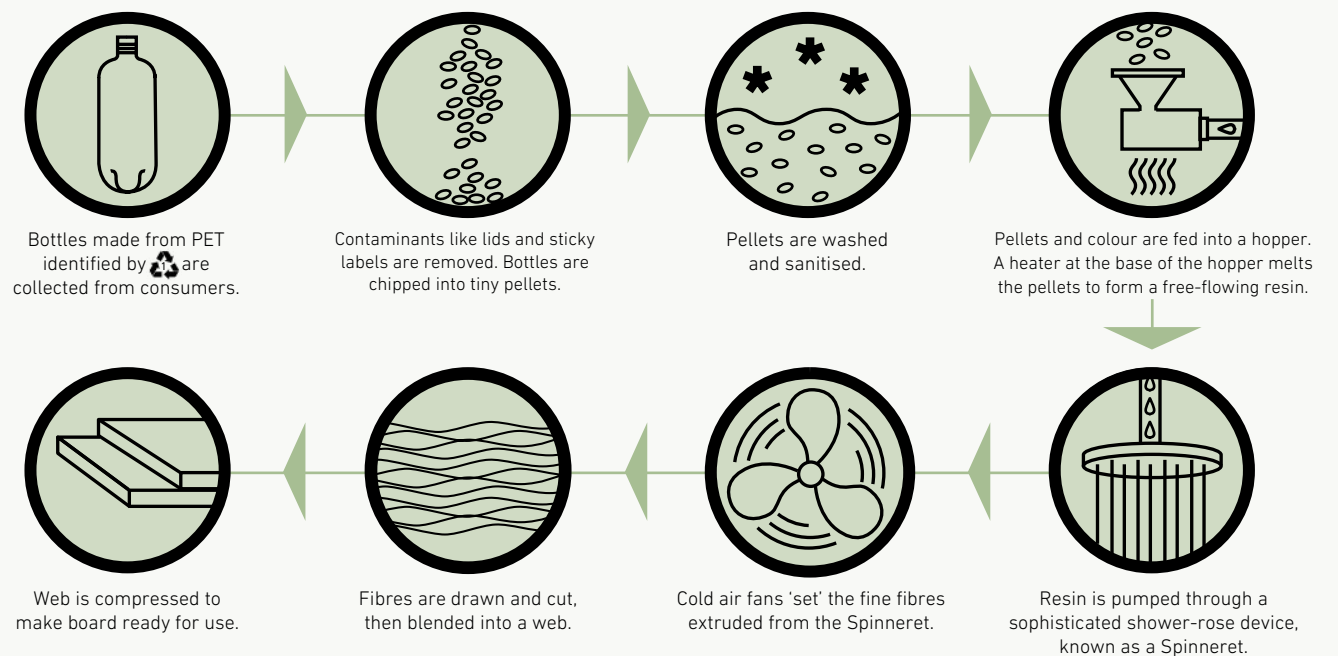

ECHOPANEL® COLLECTION

Invented and launched by Woven Image in 2004, EchoPanel® is the original decorative interior panelling solution, with acoustic qualities and eco-innovation at its core. EchoPanel® production uses post-consumer recycled PET to create a superior upcycled product. Since 2022, Woven Image have also committed to offset the embodied carbon of EchoPanel® acoustic panels to zero. Since 2023, the EchoPanel® collection has achieved carbon neutrality, as certified by Climate Active.

EchoPanel® is available in a comprehensive range of neutral, mid-tone and vibrant colours. Due to its unique manufacturing process, the colour remains consistent throughout the depth of the panel.

EchoPanel® is pinnable, durable, lightweight and easy to cut and install, making it ideal for a multitude of wall, ceiling and free-standing commercial interior applications. Available in 12mm (0.47") and 24mm (0.94") thicknesses.

- ECHOPANEL® PALETTE..... 06
- PRECISION CUT DESIGNS..... 08
 - ECHOPANEL® ORB..... 10
 - ECHOPANEL® MOSAIC 12
 - ECHOPANEL® CURRENT..... 14
 - ECHOPANEL® ISLE 16
 - ECHOPANEL® PARQUET 18
 - ECHOPANEL® LONGITUDE..... 20
 - ECHOPANEL® PALACE 22
 - ECHOPANEL® OHM 24
 - ECHOPANEL® EMPIRE 26
 - ECHOPANEL® MERIDIAN 28
 - ECHOPANEL® LATITUDE 30
 - ECHOPANEL® ALIGN..... 32



EchoPanel® 12mm In colour 660



ECHOPANEL® PALETTE



PANEL DIMENSIONS 2800mm (+/-10mm) x 1200mm (+/-5mm) | 110.24" (+/-0.39") x 47.24" (+/-0.2")

PANEL THICKNESS
12mm (+/-7%) | 0.47" (+/-7%)
24mm (+/-7%) | 0.94" (+/-7%)

SOUND ABSORPTION AS ISO 354: 2006 (R2016) - direct fix results

12mm (0.47")
 α_w 0.30 (MH)
 NRC 0.45
 SAA 0.43
 Class D

24mm (0.94")
 α_w 0.45 (MH)
 NRC 0.65
 SAA 0.63
 Class D

QUICK REFERENCE GUIDE

PANEL DIMENSIONS
12mm x 2800mm x 1200mm | **0.47"** x 110.24" x 47.24"
24mm x 2800mm x 1200mm | **0.94"** x 110.24" x 47.24"

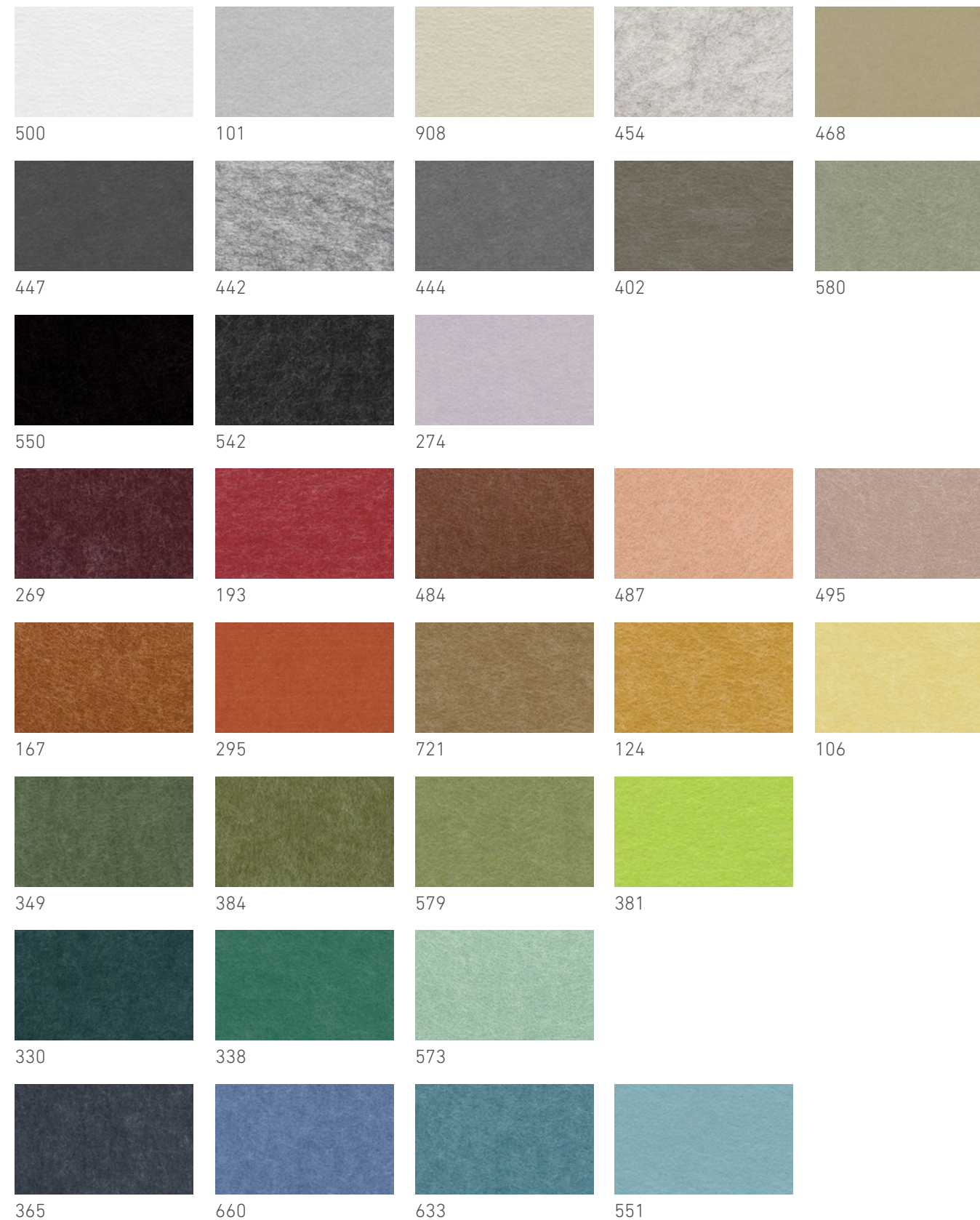
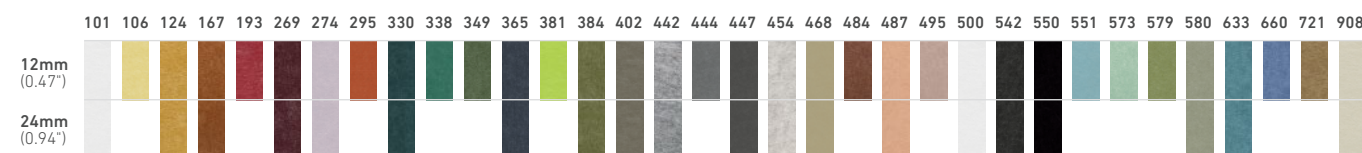

For additional specifications and performance details please visit wovenimage.com **HERE**

ECHOPANEL® COLLECTION

PRECISION CUT DESIGNS



PRECISION CUT DESIGNS

ECHOPANEL® ORB



EchoPanel® ORB in colour 495

COLOURS	Full EchoPanel® colour range - see page 7
PANEL DIMENSIONS	2750mm (+/-2mm) x 1100mm (+/-2mm) 108.27" (+/-0.08") x 43.31" (+/-0.08")
PANEL THICKNESS	12mm (+/-7%) 0.47" (+/-7%) 24mm (+/-7%) 0.94" (+/-7%)

SOUND ABSORPTION	AS ISO 354: 2006 (R2016) - direct fix results	
12mm (0.47")	α_w	0.30 (MH)
	NRC	0.45
	SAA	0.43
	Class	D
24mm (0.94")	α_w	0.45 (MH)
	NRC	0.65
	SAA	0.63
	Class	D

For additional specifications and performance details please visit wovenimage.com **HERE**

PRECISION CUT DESIGNS

ECHOPANEL® MOSAIC



EchoPanel® MOSAIC in colours 573 & 721

COLOURS	Full EchoPanel® colour range - see page 7
PANEL DIMENSIONS	2750mm (+/-2mm) x 1100mm (+/-2mm) 108.27" (+/-0.08") x 43.31" (+/-0.08")
PANEL THICKNESS	12mm (+/-7%) 0.47" (+/-7%) 24mm (+/-7%) 0.94" (+/-7%)

SOUND ABSORPTION	AS ISO 354: 2006 (R2016) - direct fix results	
12mm (0.47")	α_w	0.30 (MH)
	NRC	0.45
	SAA	0.43
	Class	D
24mm (0.94")	α_w	0.45 (MH)
	NRC	0.65
	SAA	0.63
	Class	D

For additional specifications and performance details please visit wovenimage.com **HERE**

PRECISION CUT DESIGNS

ECHOPANEL® CURRENT

EchoPanel® CURRENT in colour 454

COLOURS	Full EchoPanel® colour range - see page 7	SOUND ABSORPTION	AS ISO 354: 2006 (R2016) - direct fix results
PANEL DIMENSIONS	2750mm (+/-2mm) x 1100mm (+/-2mm) 108.27" (+/-0.08") x 43.31" (+/-0.08")	12mm (0.47")	α_w 0.30 (MH) NRC 0.45 SAA 0.43 Class D
PANEL THICKNESS	12mm (+/-7%) 0.47" (+/-7%) 24mm (+/-7%) 0.94" (+/-7%)	24mm (0.94")	α_w 0.45 (MH) NRC 0.65 SAA 0.63 Class D

For additional specifications and performance details please visit [wovenimage.com](https://www.wovenimage.com) **HERE**

PRECISION CUT DESIGNS

ECHOPANEL® ISLE

EchoPanel® ISLE in colour 106

COLOURS

Full EchoPanel® colour range - see page 7

PANEL DIMENSIONS

2750mm (+/-2mm) x 1100mm (+/-2mm) | 108.27" (+/-0.08") x 43.31" (+/-0.08")

PANEL THICKNESS

12mm (+/-7%) | 0.47" (+/-7%)

24mm (+/-7%) | 0.94" (+/-7%)

SOUND ABSORPTION

AS ISO 354: 2006 (R2016) - direct fix results

12mm	α_w	0.30 (MH)
(0.47")	NRC	0.45
	SAA	0.43
	Class	D

24mm	α_w	0.45 (MH)
(0.94")	NRC	0.65
	SAA	0.63
	Class	D

For additional specifications and performance details please visit wovenimage.com **HERE**

PRECISION CUT DESIGNS

ECHOPANEL® PARQUET



EchoPanel® PARQUET in colour 495

COLOURS	Full EchoPanel® colour range - see page 7
PANEL DIMENSIONS	2750mm (+/-2mm) x 1100mm (+/-2mm) 108.27" (+/-0.08") x 43.31" (+/-0.08")
PANEL THICKNESS	12mm (+/-7%) 0.47" (+/-7%) 24mm (+/-7%) 0.94" (+/-7%)

SOUND ABSORPTION	AS ISO 354: 2006 (R2016) - direct fix results	
12mm (0.47")	α_w	0.30 (MH)
	NRC	0.45
	SAA	0.43
	Class	D
24mm (0.94")	α_w	0.45 (MH)
	NRC	0.65
	SAA	0.63
	Class	D

For additional specifications and performance details please visit wovenimage.com **HERE**

PRECISION CUT DESIGNS

ECHOPANEL® LONGITUDE



EchoPanel® LONGITUDE in colour 447

COLOURS	Full EchoPanel® colour range - see page 7
PANEL DIMENSIONS	2750mm (+/-2mm) x 1100mm (+/-2mm) 108.27" (+/-0.08") x 43.31" (+/-0.08")
PANEL THICKNESS	12mm (+/-7%) 0.47" (+/-7%) 24mm (+/-7%) 0.94" (+/-7%)

SOUND ABSORPTION	AS ISO 354: 2006 (R2016) - direct fix results	
12mm (0.47")	α_w	0.30 (MH)
	NRC	0.45
	SAA	0.43
	Class	D
24mm (0.94")	α_w	0.45 (MH)
	NRC	0.65
	SAA	0.63
	Class	D

For additional specifications and performance details please visit [wovenimage.com](https://www.wovenimage.com) **HERE**

PRECISION CUT DESIGNS

ECHOPANEL® PALACE

EchoPanel® PALACE in colour 349

COLOURS

Full EchoPanel® colour range - see page 7

PANEL DIMENSIONS

2750mm (+/-2mm) x 1100mm (+/-2mm) | 108.27" (+/-0.08") x 43.31" (+/-0.08")

PANEL THICKNESS

12mm (+/-7%) | 0.47" (+/-7%)

24mm (+/-7%) | 0.94" (+/-7%)

SOUND ABSORPTION

AS ISO 354: 2006 (R2016) - direct fix results

12mm (0.47")	α_w	0.30 (MH)
	NRC	0.45
	SAA	0.43
	Class	D

24mm (0.94")	α_w	0.45 (MH)
	NRC	0.65
	SAA	0.63
	Class	D

For additional specifications and performance details please visit [wovenimage.com](https://www.wovenimage.com) **HERE**

PRECISION CUT DESIGNS

ECHOPANEL® OHM

EchoPanel® OHM in colour 454

COLOURS	Full EchoPanel® colour range - see page 7	SOUND ABSORPTION	AS ISO 354: 2006 (R2016) - direct fix results
PANEL DIMENSIONS	2750mm (+/-2mm) x 1100mm (+/-2mm) 108.27" (+/-0.08") x 43.31" (+/-0.08")	12mm (0.47")	α_w 0.30 (MH) NRC 0.45 SAA 0.43 Class D
PANEL THICKNESS	12mm (+/-7%) 0.47" (+/-7%) 24mm (+/-7%) 0.94" (+/-7%)	24mm (0.94")	α_w 0.45 (MH) NRC 0.65 SAA 0.63 Class D

For additional specifications and performance details please visit [wovenimage.com](https://www.wovenimage.com) **HERE**

PRECISION CUT DESIGNS

ECHOPANEL® EMPIRE



EchoPanel® EMPIRE in colour 365

COLOURS	Full EchoPanel® colour range - see page 7
PANEL DIMENSIONS	2750mm (+/-2mm) x 1100mm (+/-2mm) 108.27" (+/-0.08") x 43.31" (+/-0.08")
PANEL THICKNESS	12mm (+/-7%) 0.47" (+/-7%) 24mm (+/-7%) 0.94" (+/-7%)

SOUND ABSORPTION	AS ISO 354: 2006 (R2016) - direct fix results	
12mm (0.47")	α_w	0.30 (MH)
	NRC	0.45
	SAA	0.43
	Class	D
24mm (0.94")	α_w	0.45 (MH)
	NRC	0.65
	SAA	0.63
	Class	D

For additional specifications and performance details please visit wovenimage.com **HERE**



PRECISION CUT DESIGNS

ECHOPANEL® MERIDIAN



EchoPanel® MERIDIAN in colours 580 & 454

COLOURS	Full EchoPanel® colour range - see page 7
PANEL DIMENSIONS	2750mm (+/-2mm) x 1100mm (+/-2mm) 108.27" (+/-0.08") x 43.31" (+/-0.08")
PANEL THICKNESS	12mm (+/-7%) 0.47" (+/-7%) 24mm (+/-7%) 0.94" (+/-7%)

SOUND ABSORPTION	AS ISO 354: 2006 (R2016) - direct fix results	
12mm (0.47")	α_w	0.30 (MH)
	NRC	0.45
	SAA	0.43
	Class	D
24mm (0.94")	α_w	0.45 (MH)
	NRC	0.65
	SAA	0.63
	Class	D

For additional specifications and performance details please visit wovenimage.com **HERE**

PRECISION CUT DESIGNS

ECHOPANEL® LATITUDE



EchoPanel® LATITUDE in colour 384

COLOURS	Full EchoPanel® colour range - see page 7
PANEL DIMENSIONS	2750mm (+/-2mm) x 1100mm (+/-2mm) 108.27" (+/-0.08") x 43.31" (+/-0.08")
PANEL THICKNESS	12mm (+/-7%) 0.47" (+/-7%) 24mm (+/-7%) 0.94" (+/-7%)

SOUND ABSORPTION	AS ISO 354: 2006 (R2016) - direct fix results	
12mm (0.47")	α_w	0.30 (MH)
	NRC	0.45
	SAA	0.43
	Class	D
24mm (0.94")	α_w	0.45 (MH)
	NRC	0.65
	SAA	0.63
	Class	D

For additional specifications and performance details please visit wovenimage.com **HERE**

PRECISION CUT DESIGNS

ECHOPANEL® ALIGN



EchoPanel® ALIGN in colour 349

COLOURS	Full EchoPanel® colour range - see page 7
PANEL DIMENSIONS	2750mm (+/-2mm) x 1180mm (+/-2mm) 108.27" (+/-0.08") x 46.46" (+/-0.08")
PANEL THICKNESS	12mm (+/-7%) 0.47" (+/-7%) 24mm (+/-7%) 0.94" (+/-7%)

SOUND ABSORPTION	AS ISO 354: 2006 (R2016) - direct fix results	
12mm (0.47")	α_w	0,30 (MH)
	NRC	0,45
	SAA	0,43
	Class	D
24mm (0.94")	α_w	0,45 (MH)
	NRC	0,65
	SAA	0,63
	Class	D

For additional specifications and performance details please visit wovenimage.com **HERE**

CEILING COLLECTION

Woven Image offer design-driven and high-performance acoustic ceiling solutions, to control reverberated noise in commercial interior spaces.

EchoPanel® Array is an acoustic ceiling baffle solution utilising 12mm (0.47”) and 24mm (0.94”) EchoPanel®, with streamlined hardware engineered for easy installation, and scalable for both small and large applications. Choose from beautifully crafted baffles in the extensive EchoPanel® colour palette, or work with us to create your own unique designs.

Fuji is a range of decorative 3D formed ceiling tiles, offering superb acoustic absorption. Fuji tiles can be installed with or without the Array ceiling hardware, with options to direct-fix or suspend from the ceiling and integrate a variety of lighting options.

EchoPanel® Element comprises of a series of cut EchoPanel® blades which slot together to form a square lattice. Element can be attached to existing ceiling grids, or directly fixed or suspended from the ceiling.

Woven Image’s inhouse Commercial Service team provide industry expertise, advice and CAD technical plans and drawings, to ensure ceiling projects are delivered to the highest standards.

ECHOPANEL® ARRAY.....	36
FUJI.....	40
ECHOPANEL® ELEMENT.....	44

EchoPanel® and Fuji achieve:



CEILING COLLECTION

ECHOPANEL® ARRAY

12mm & 24mm

EchoPanel® Array baffle and ceiling hardware dimensions will vary depending on project requirements. Exact quantities, measurements and drawings will be provided upon project specification.

Standard baffle designs are 2780mm in length and vary in depth, please see below:

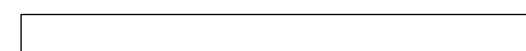
BEAM

2780mm length x 200mm depth (+/-5mm)

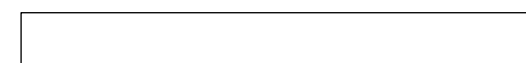

2780mm length x 300mm depth (+/-5mm)

WEDGE

2780mm length x 200mm depth (+/-5mm)

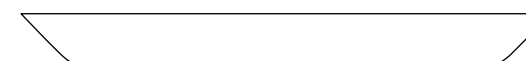

2780mm length x 300mm depth (+/-5mm)

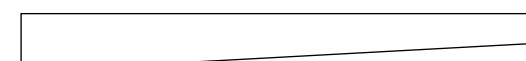
TAPER

2780mm length x 300mm depth (+/-5mm)

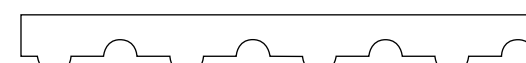
CATHEDRAL

2780mm length x 300mm depth (+/-5mm)

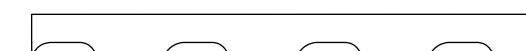
TURRET

2780mm length x 300mm depth (+/-5mm)

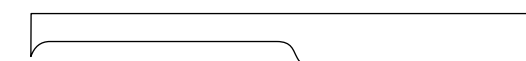
VALLEY

2780mm length x 300mm depth (+/-5mm)

VIADUCT

2780mm length x 300mm depth (+/-5mm)

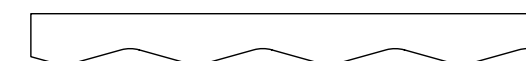
WAVE

2780mm length x 267mm depth (+/-5mm)

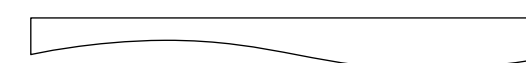
FLOW

2780mm length x 300mm depth (+/-5mm)

For additional specifications and performance details please visit wovenimage.com **HERE**



ECHOPANEL® 24mm in colours 384, 468 & 580 & ECHOPANEL® 12mm in colours 167, 269 & 468
 Project: University of Adelaide | Designer: Architectus | Photography: Aaron Citti

COLOURS Full EchoPanel® colour range - see page 7

DIMENSIONS For standard baffle styles & dimensions - see page 37

SOUND ABSORPTION **12mm (+/-7%)** | 0.47" (+/-7%) - direct fix results
 AS ISO 354: 2006 (R2016)
 AS ISO 11654: 2002 (2016)
 ASTM C423 - 17

α_w	0.65 (H)
NRC	0.70
SAA	0.68
Class	C

SOUND ABSORPTION **24mm (+/-7%)** | 0.94" (+/-7%) - direct fix results
 AS ISO 354: 2006 (R2016)
 AS ISO 11654: 2002 (2016)
 ASTM C423 - 17

α_w	0.75 (MH)
NRC	0.85
SAA	0.83
Class	C

For additional specifications and performance details please visit wovenimage.com **HERE**



CEILING COLLECTION

FUJI

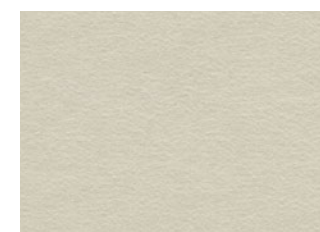

908

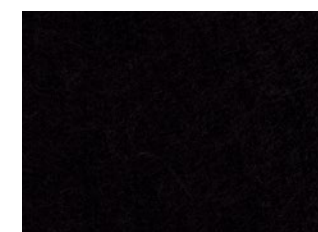

550



299

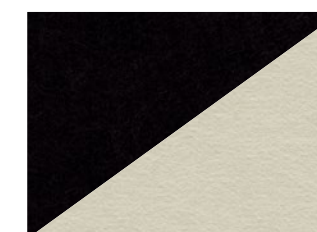

420



ARRAY RAILS in colours black & white



BARREL KITS in colours onyx, off-white & onyx/gold

COLOURS

Stocked in 4 standard colours – full Mura colour range available on request, see page 58. Barrel kits allow Fuji tiles to be directly fixed to the ceiling or to the Array ceiling rail.

DIMENSIONS

FUJI JUNI 560mm (+/-3mm) x 1160mm (+/-3mm) x 90mm (+/-3mm)
22.05" (+/-0.12") x 45.67" (+/-0.12") x 3.54" (+/-0.12")

FUJI HACHI 1740mm (+/-3mm) x 840mm (+/-3mm) x 132mm (+/-3mm)
68.5" (+/-0.12") x 33.07" (+/-0.12") x 5.2" (+/-0.12")

THICKNESS

4.6mm (+/-2mm) | 0.18" (+/-0.08")

SOUND ABSORPTION

AS ISO 11654: 2002 (2016) | AS ISO 354: 2006 (R2016) | ASTM C423 - 17, with perimeter

FUJI JUNI	α_w	0.80
	NRC	0.80
	SAA	0.76

FUJI HACHI	α_w	0.85
	NRC	0.80
	SAA	0.76

For additional specifications and performance details please visit wovenimage.com **HERE**



CEILING COLLECTION

FUJI



FUJI KU in colour 550 | Project: JQZ Office | Design & Installation: Sheldon Interiors | Photographer: Simon Whitbread

COLOURS Stocked in 4 standard colours – full Mura colour range available on request, see page 58. Barrel kits allow Fuji tiles to be directly fixed to the ceiling or to the Array ceiling rail.

DIMENSIONS

FUJI ROKU 560mm (+/-3mm) x 560mm (+/-3mm) x 90mm (+/-3mm)
22.05" (+/-0.12") x 22.05" (+/-0.12") x 3.54" (+/-0.12")

FUJI KU 840mm (+/-3mm) x 840mm (+/-3mm) x 132mm (+/-3mm)
33.07" (+/-0.12") x 33.07" (+/-0.12") x 5.2" (+/-0.12")

THICKNESS 4.6mm (+/-2mm) | 0.18" (+/-0.08")

SOUND ABSORPTION AS ISO 11654: 2002 (2016) | AS ISO 354: 2006 (R2016) | ASTM C423 - 17, with perimeter

FUJI ROKU	α_w	0.75
	NRC	0.70
	SAA	0.72
FUJI KU	α_w	0.80
	NRC	0.75
	SAA	0.74

For additional specifications and performance details please visit wovenimage.com **HERE**



CEILING COLLECTION

ECHOPANEL® ELEMENT

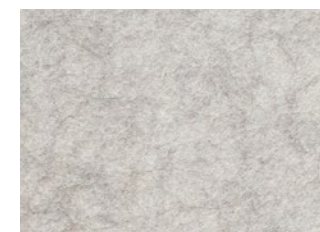

454

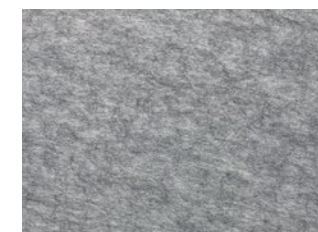

442



542



EchoPanel® ELEMENT in colour 454 suspended



EchoPanel® ELEMENT in colour 442 clipped to ceiling grid

ASSEMBLED DIMENSIONS 2350mm (+/-2mm) x 2350mm (+/-2mm) x 215mm (+/-2mm)
92.52" (+/-0.08") x 92.52" (+/-0.08") x 8.46" (+/-0.08")

BLADE THICKNESS 24mm (+/-7%) | 0.94" (+/-7%)

SOUND ABSORPTION AS ISO 11654: 2002 (2016)
ASTM C423 - 17

α _w	0.40
NRC	0.35
SAA	0.36
Class	D

BOX COMPONENTS 8 x EchoPanel® blades
16 x ceiling clips
Suspension kit sold separately

For additional specifications and performance details please visit wovenimage.com **HERE**

SPACE DIVIDING COLLECTION

Our range of EchoPanel® space dividing systems includes hanging pendants and free-standing room dividers.

These products allow open plan spaces, typical of modern workplace and hospitality environments, to be partitioned with ease and flexibility whilst reducing reverberated noise to improve both comfort and productivity.

HANGING PENDENTS.....	48
PALING.....	50
PLATOON.....	52



SPACE DIVIDING COLLECTION

HANGING PENDENTS

12mm | 0.47"

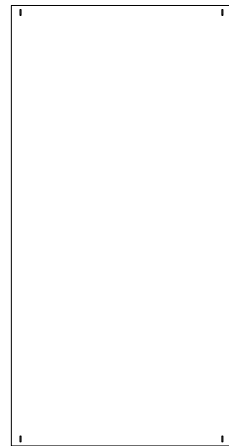

TANDEM 12mm | 0.47"

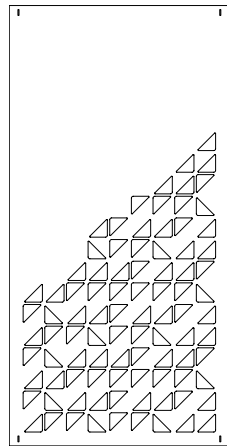

SUMMIT 12mm | 0.47"

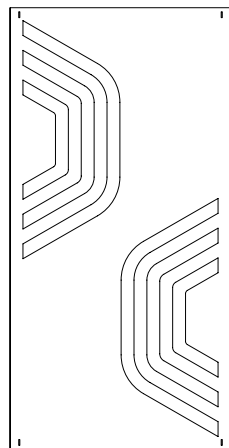

DOT 12mm | 0.47"

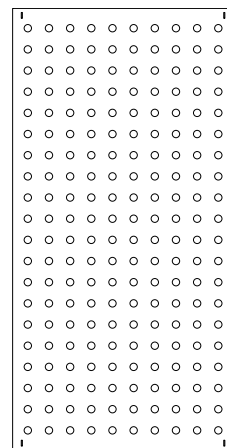

SPLAY 12mm | 0.47"

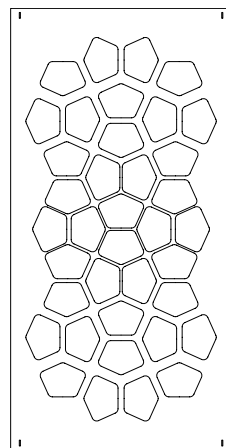

COLOURS

Full EchoPanel® 12mm (0.47") colour range - see page 7

PENDENT DESIGNS

5 styles

PANEL DIMENSIONS

12mm (+/-7%) | 0.47" (+/-7%)
2400mm (+/-2mm) x 1200mm (+/-10mm)
94.49" (+/-0.08") x 47.24" (+/-0.39")

SOUND ABSORPTION

See EchoPanel® 12mm (0.47") on page 6 for details

BOX COMPONENTS

1 x cut EchoPanel® 12mm (0.47")
1 x 12mm hanging pendent component kit

For additional specifications and performance details please visit wovenimage.com **HERE**

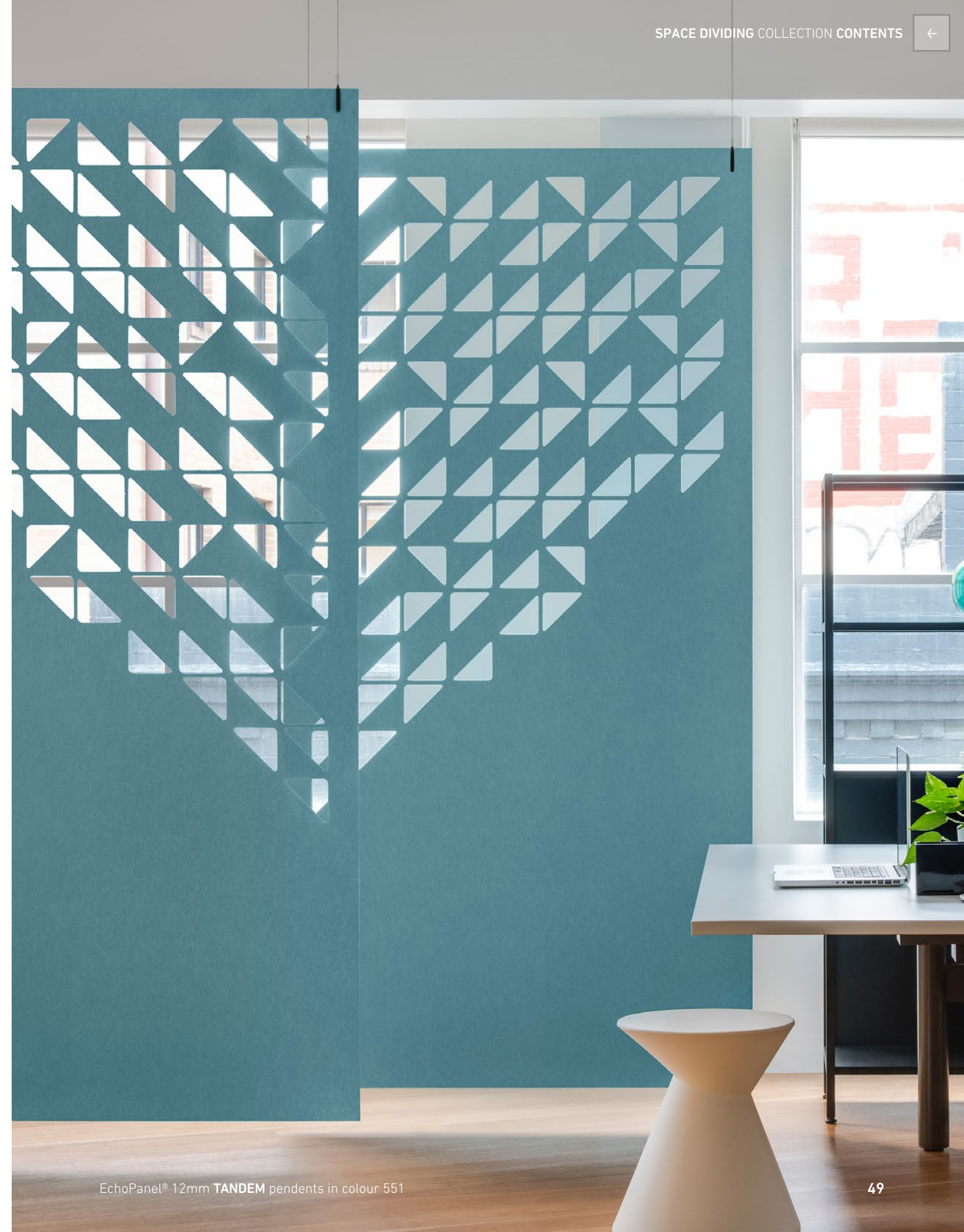

SPACE DIVIDING COLLECTION

PALING

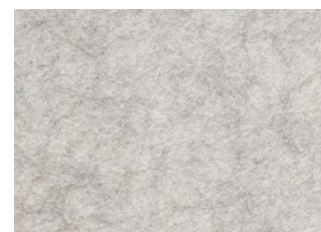

454

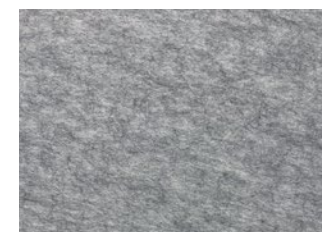

442



542

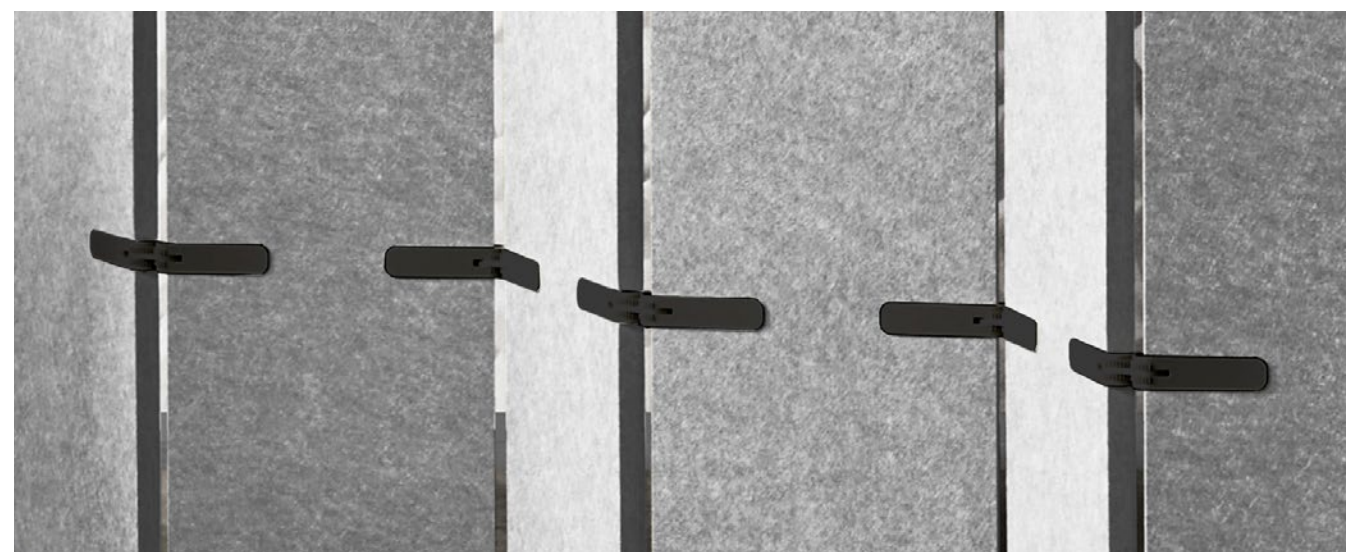

EchoPanel® PALING in colour 442 with charcoal pivot joiners

PRODUCT TYPE	Free-standing system
PANEL DIMENSIONS	PALING A (end panel) & B (middle panel) 285mm (+/-2mm) x 1750mm (+/-2mm) 11.22" (+/-0.08") x 68.9" (+/-0.08")
PANEL THICKNESS	24mm (+/-7%) 0.94" (+/-7%)
PIVOT JOINER COLOURS	Cream and charcoal - to be specified in order
SOUND ABSORPTION	See EchoPanel® 24mm (0.94") on page 6 for details

For additional specifications and performance details please visit [wovenimage.com](https://www.wovenimage.com) **HERE**

SPACE DIVIDING COLLECTION

PLATOON



PLATOON in colours 442 & 542 with charcoal pivot joiners

PRODUCT TYPE	Free-standing system
FULL PRODUCT DIMENSIONS	1750mm (+/-2mm) x 3500mm (+/-2mm) 68.9" (+/-0.08") x 137.8" (+/-0.08")
PANEL THICKNESS	24mm (+/-7%) 0.94" (+/-7%)
PIVOT JOINER COLOURS	Cream and charcoal - to be specified in order
SOUND ABSORPTION	See EchoPanel® 24mm (0.94") on page 6 for details
BOX COMPONENTS	6 x PLATOON panels 10 x pivot joiners

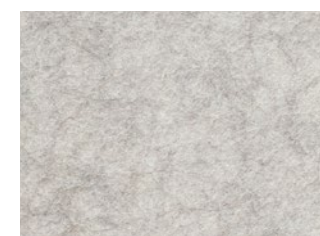

454



442



542

For additional specifications and performance details please visit wovenimage.com **HERE**

MURA COLLECTION

Mura is an innovative and versatile, 1.9mm (0.075") thick, surface finish that is highly cost effective, easy to install and boasts an on-trend colour palette. The face side has been designed to create a smooth clean look, whilst the back has been engineered with a forgiving texture that can be adhered to a variety of surfaces including walls, workstation screens and operable walls.

Made from 60% recycled PET with low VOCs, Mura has the same first-rate environmental certifications as EchoPanel®.

MURA PALETTE 56



Wall: MURA in colour 454
Desk screen: MURA in colour 551

MURA COLLECTION

MURA PALETTE

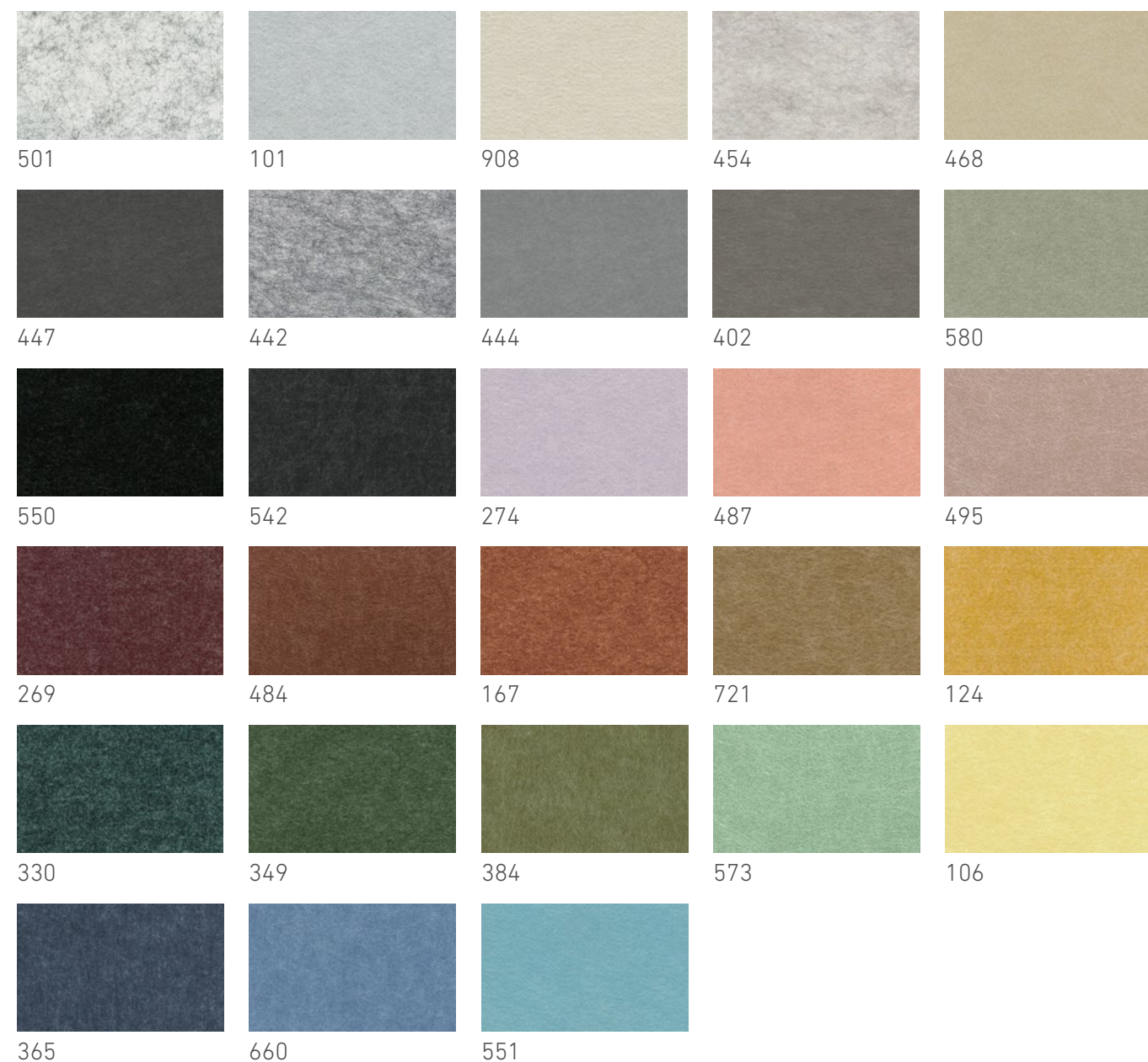

ROLL DIMENSIONS 6m, 25m or 105m roll | 236", 984" or 4134" roll

ROLL WIDTH 1210mm (+/-5mm) | 47.64" (+/-0.2")

THICKNESS **1.9mm** (+/-0.25mm) | 0.07" (+/-0.01")

SOUND ABSORPTION AS ISO 354: 2006 (R2016) - direct fix results

α _w	0.10 (H)
NRC Value	0.10
SAA	0.08



For additional specifications and performance details please visit wovenimage.com **HERE**

ECHOFLEX COLLECTION

ECHOFLEX 60

EchoFlex is a durable, velcro receptive acoustic wallcovering with a soft fibre-finish, ideal for educational and aged care interior applications.

Able to be cut and installed to curved surfaces, unique applications can be easily achieved. With an extensive colour palette that co-ordinates with the popular EchoPanel® acoustic panel range, EchoFlex is easily integrated into commercial interior design.



ECHOFLEX in colours 384 & 580
with EchoPanel® 12mm 454 on arch





ECHOFLEX COLLECTION

ECHOFLEX



ECHOFLEX in colour 124



60 ECHOFLEX in colour 454

101	908	454	402	580
542	447	442	269	495
484	167	721	124	106
349	384	365	551	573

ROLL DIMENSIONS	25m (+/-25mm) 984" (+/-0.98")
ROLL WIDTH	1220mm (+/-2mm) 48" (+/-0.08")
THICKNESS	10-12mm (+/-2mm) 0.39"-0.47" (+/-0.01")
SOUND ABSORPTION	AS ISO 354: 2006 (R2016) AS ISO 11654: 2002 (2016) ASTM C423 - 17 - direct fix results
	α_w 0.35 (H)
	NRC 0.40
	SAA 0.41
	Class 1 or A

For additional specifications and performance details please visit wovenimage.com **HERE**

EMBOSSSED PANEL COLLECTION

The embossed acoustic panel collection from Woven Image is made using recycled PET. This design-led range embraces the trend towards tactile surfaces and three-dimensional textures, interweaving cutting-edge design with sustainability and commercial performance.

Available in five unique designs; Zen, Ion, Gem, Pico and Umi which have been specially designed to provide a floor-to-ceiling acoustic solution for commercial office interiors and pattern matches for continuous wall and double-height installations.

The collection has won numerous international design awards including; The Designer Award for Innovation in Material Product Design, the Dezeen Award for Workplace Design, the FX Design Award for Best Surface, the Architizer Award for A+ Products and an INDE Award.

The uniqueness of the design was observed instantly by the Dezeen Awards judges who said that "in this instance, there was an attempt to define the space in sculptural terms and also give the product tactility". The Dezeen Awards received more than 4,300 entries, from 85 countries across 5 continents.

PICO 64

ZEN 66

ION 68

GEM 70

UMI 72



ZEN in colour 365



EMBOSSSED PANEL COLLECTION

PICO



PANEL DIMENSIONS 2800mm (+/-3mm) x 1130mm (+/-3mm) | 110.24" (+/-0.12") x 44.49" (+/-0.12")

PANEL THICKNESS 9mm (+/-7%) | 0.35" (+/-7%)

SOUND ABSORPTION AS ISO 354: 2006 (R2016) - direct fix results

α_w	0.20 (H)
NRC	0.30
SAA	0.28
Class	E

For additional specifications and performance details please visit wovenimage.com **HERE**

EMBOSSSED PANEL COLLECTION

ZEN



PANEL DIMENSIONS 2800mm (+/-3mm) x 1130mm (+/-3mm) | 110.24" (+/-0.12") x 44.49" (+/-0.12")

PANEL THICKNESS 9mm (+/-7%) | 0.35" (+/-7%)

SOUND ABSORPTION AS ISO 354: 2006 (R2016) - direct fix results

α_w 0.20 (H)
 NRC 0.30
 SAA 0.28
 Class E

For additional specifications and performance details please visit wovenimage.com **HERE**

EMBOSSSED PANEL COLLECTION

ION



PANEL DIMENSIONS 2800mm (+/-3mm) x 1130mm (+/-3mm) | 110.24" (+/-0.12") x 44.49" (+/-0.12")

PANEL THICKNESS 9mm (+/-7%) | 0.35" (+/-7%)

SOUND ABSORPTION AS ISO 354: 2006 (R2016) - direct fix results

α_w	0.20 (H)
NRC	0.30
SAA	0.28
Class	E

For additional specifications and performance details please visit wovenimage.com **HERE**



EMBOSSED PANEL COLLECTION

GEM



101

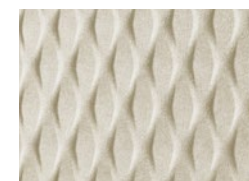

908



468



402



580

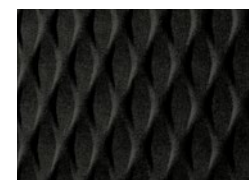

550

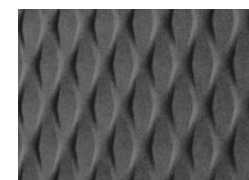

447



274



487

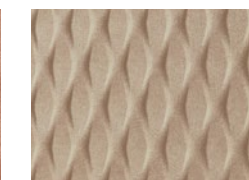

495

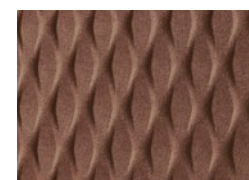

484

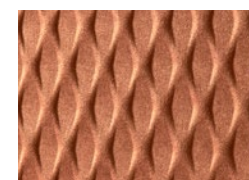

167



721



124



106

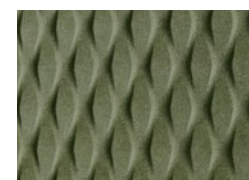

384



349

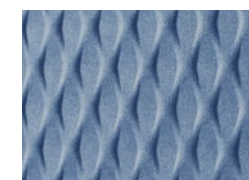

660



551

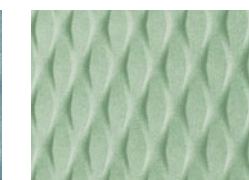

573

PANEL DIMENSIONS 2800mm (+/-3mm) x 1130mm (+/-3mm) | 110.24" (+/-0.12") x 44.49" (+/-0.12")

PANEL THICKNESS 9mm (+/-7%) | 0.35" (+/-7%)

SOUND ABSORPTION AS ISO 354: 2006 (R2016) - direct fix results

α_w 0.20 (H)

NRC 0.30

SAA 0.28

Class E

For additional specifications and performance details please visit wovenimage.com **HERE**

EMBOSSSED PANEL COLLECTION

UMI



PANEL DIMENSIONS 2800mm (+/-3mm) x 1130mm (+/-3mm) | 110.24" (+/-0.12") x 44.49" (+/-0.12")

PANEL THICKNESS 9mm (+/-7%) | 0.35" (+/-7%)

SOUND ABSORPTION AS ISO 354: 2006 (R2016) - direct fix results

αw 0.20 (H)
 NRC 0.30
 SAA 0.28
 Class E

[Link to update](#)

For additional specifications and performance details please visit wovenimage.com **HERE**



UMI in colour 330

3D FORMED PANEL COLLECTION

COLUMN 76

CURTAIN 78

Commercial interiors are scaled to new levels of comfort, class and sophistication with floor-to-ceiling 3D formed panel solutions, Column and Curtain. At 2.8m high these panels can be installed without a floor-to-ceiling join, and contains over 50% post-consumer recycled PET. Panel joins and edge trims can be purchased separately, to suit installation preferences.

Column is inspired by the undulating symmetrical rhythms of the classical architectural innovation. Due to the design of wave-like peaks and troughs, coupled with a depth of approximately 70mm and a combination of non-woven raw materials, significant airgaps are captured in a direct fix wall application, creating a distinct sound absorption zone.

Curtain, the asymmetrical cousin to Column, takes on a more free-form fluid appearance. Designed with an airgap in direct fix wall applications, it displays as a contemporary acoustic macro 'curtain effect' where the non-woven materials appear to ebb and flow across a three-dimensional form.

Both designs create a unique visual delight while delivering strong acoustic performance. As the boundaries of standard interior surfaces are continually pushed, Curtain and Column are an elegant solution embracing this concept in their aesthetic, acoustic and sustainability performance.



3D FORMED PANEL COLLECTION

COLUMN

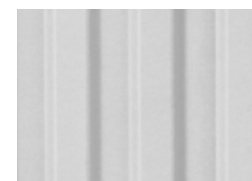

101



908



454



495

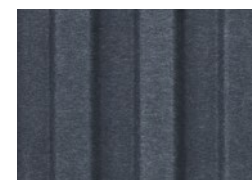

365

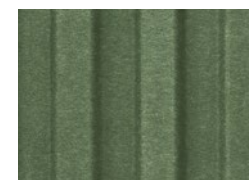

349



721



573



COLUMN in colour 454

PANEL DIMENSIONS

2800mm (+/-5mm) x 995mm (+10/-5mm) x 70mm (+/-5mm)
 110.24" (/ -0.2") x 39.17" (+0.39/-0.2") x 2.76" (+/-0.2")

PANEL THICKNESS

9mm (+/-5mm) | 0.35" (+/-7%)

SOUND ABSORPTION

AS ISO 354: 2006 (R2016) - direct fix results

α _w	0.65 (H)
NRC	0.65
SAA	0.67
Class	C

For additional specifications and performance details please visit wovenimage.com **HERE**

3D FORMED PANEL COLLECTION

CURTAIN

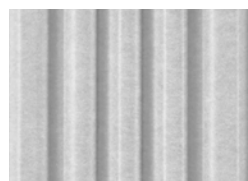

101



908

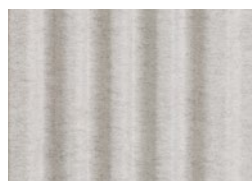

454



495

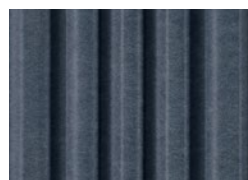

365



349



721



573

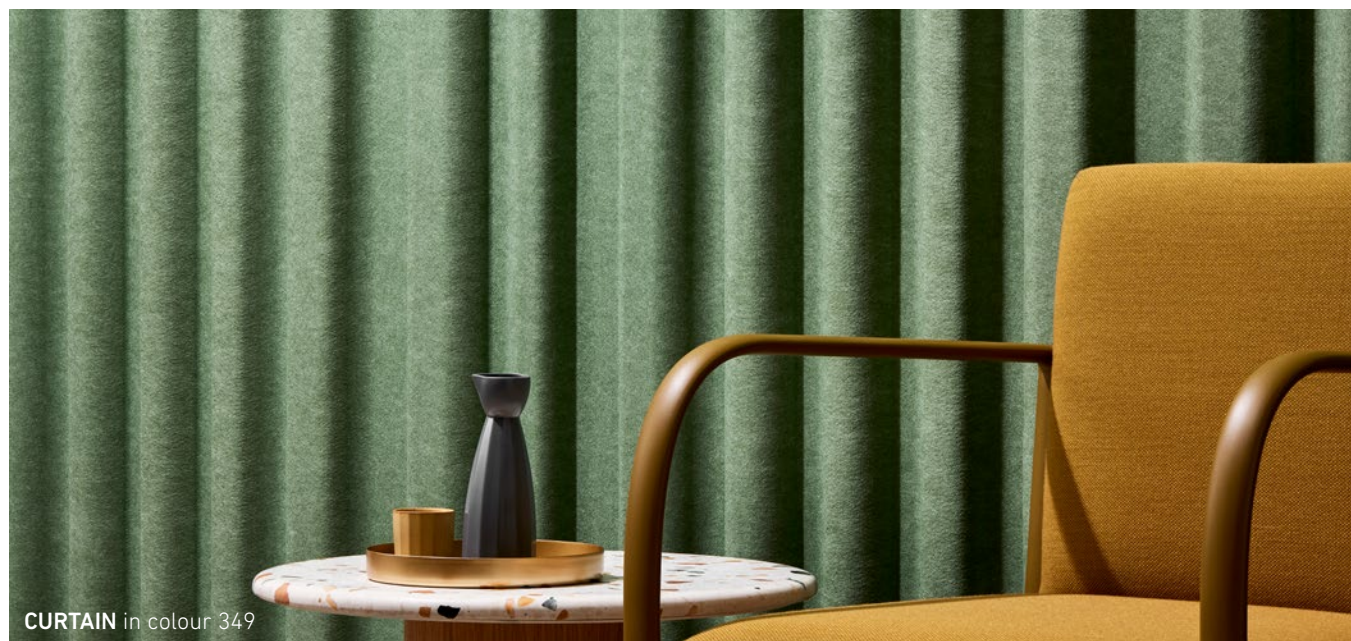

CURTAIN in colour 349

PANEL DIMENSIONS 2800mm (+/-5mm) x 975mm (+10/-5mm) x 45mm (+/-5mm)
110.24" (/ -0.2") x 38.39" (+0.39/-0.2") x 1.77" (+/-0.2")

PANEL THICKNESS 9mm (+/-7%) | 0.35" (+/-7%)

SOUND ABSORPTION AS ISO 354: 2006 (R2016) - direct fix results

α _w	0.50 (H)
NRC	0.60
SAA	0.60
Class	D

For additional specifications and performance details please visit wovenimage.com **HERE**



CURTAIN in colour 908

ACOUSTIC TILE COLLECTION

BALANCE 82

ASCENT 84

DUNE 86

WAVE 88

Whether your interiors project requires large scale coverage or to create smaller design features, this range provides an endless stream of design configurations that provide great aesthetics whilst controlling reverberated noise in;

- Collaborative workspaces and meeting rooms
- Classrooms and music rooms
- Cafés and restaurants
- Lobbies and public spaces

They are lightweight, easy to install, and pattern match without the need for trimming.

Tiles in this collection are made from EchoPanel® or Mura, which achieve first-rate environmental certifications.



ACOUSTIC TILE COLLECTION

BALANCE

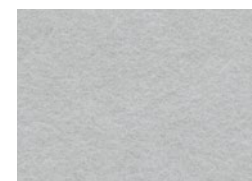

101

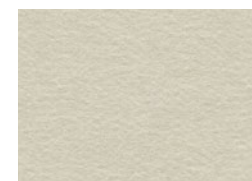

908

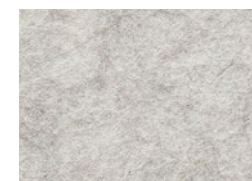

454

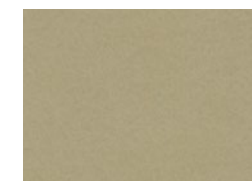

468



402

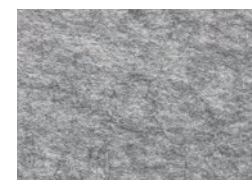

442

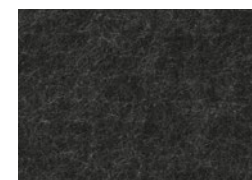

542



550

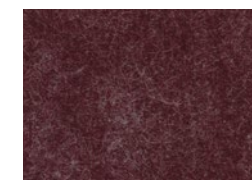

269

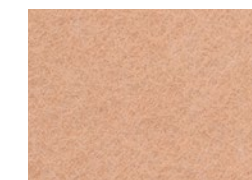

487



384

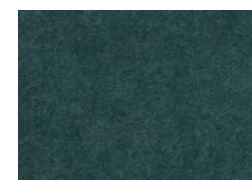

330

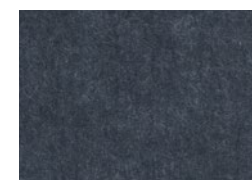

365

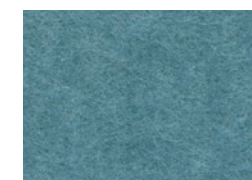

633

PRODUCT NAME

BALANCE 670
BALANCE 1340

TILE THICKNESS

12mm (+/-7%) | 0.47" (+/-7%)

SOUND ABSORPTION

AS ISO 354: 2006 (R2016)
- direct fix results
 α_w 0.45 (MH)
NRC 0.65
SAA 0.63
Class D

BOX COMPONENTS

BALANCE 670 - 12 x tiles
BALANCE 1340 - 6 x tiles

BALANCE 670

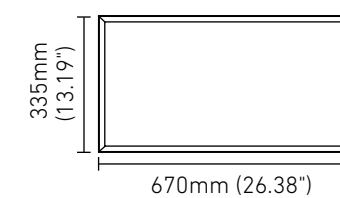

BALANCE 1340

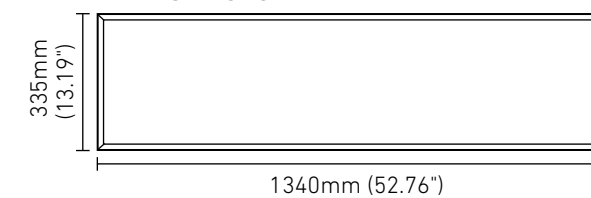

ACOUSTIC TILE COLLECTION

ASCENT

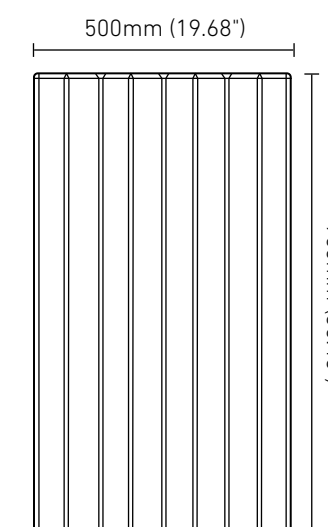
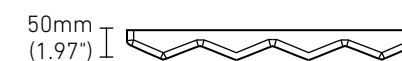
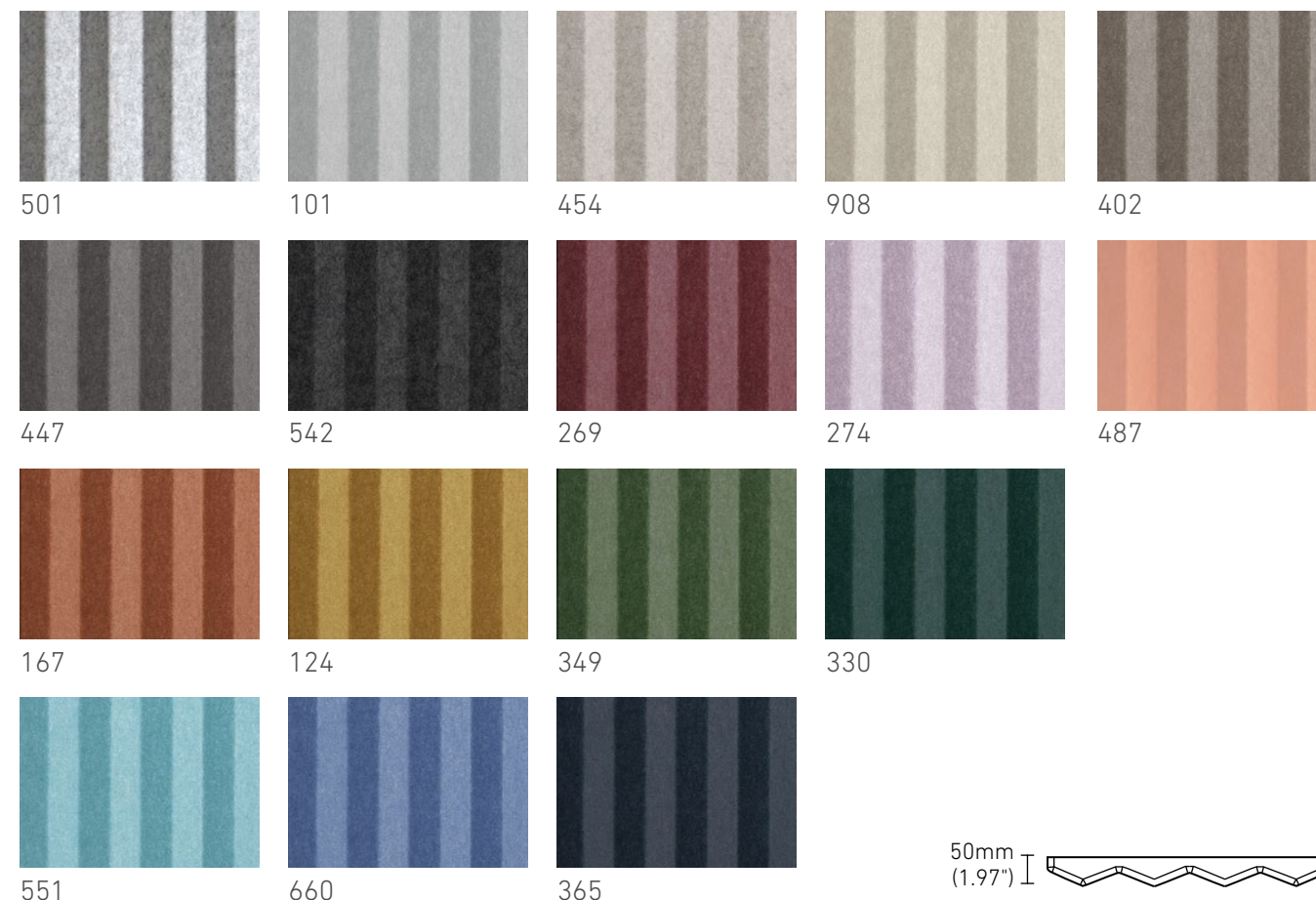

TILE DIMENSIONS 500mm (+/-5mm) x 900mm (+/-5mm) x 50mm (+/-5mm)
19.68" (+/-0.2") x 35.43" (+/-0.2") x 1.97" (+/-0.2")

TILE THICKNESS 4mm (+/-0.5mm) | 0.16" (+/-0.02")
measured 10mm (0.39") above trimmed edge

SOUND ABSORPTION AS ISO 354: 2006 (R2016) - direct fix results
αw 0.60 (MH)
NRC 0.70
SAA 0.66
Class C

BOX COMPONENTS 6 x tiles, 16 x installation clips



Declare.

ACOUSTIC TILE COLLECTION

DUNE



908



101

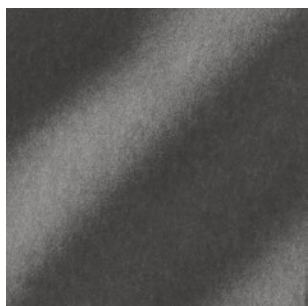

447

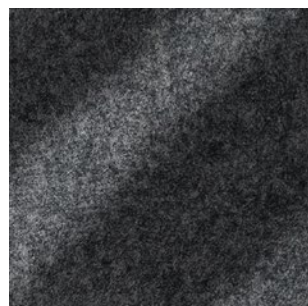

542

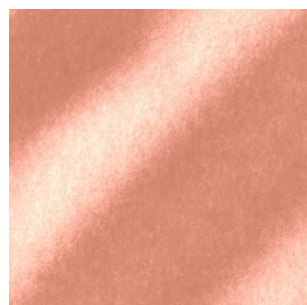

487

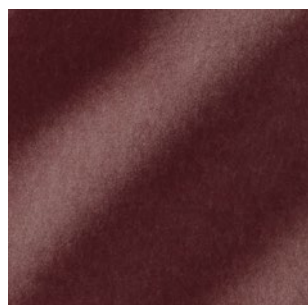

269

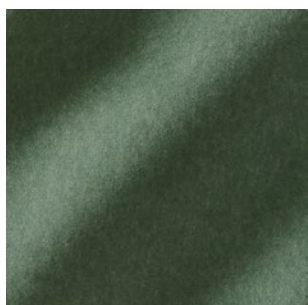

349



660

TILE DIMENSIONS

500mm (+/-5mm) x 500mm (+/-5mm) x 50mm (+/-5mm)
19.69" (+/-0.2") x 19.69" (+/-0.2") x 1.97" (+/-0.2")

TILE THICKNESS

4mm (+/-0.5mm) | 0.16" (+/-0.02") - measured 0.39" (10mm) above trimmed edge

SOUND ABSORPTION

AS ISO 354: 2006 (R2016) - direct fix results

α_w 0.50 (MH)
NRC 0.60
SAA 0.58
Class D

BOX COMPONENTS

9 x tiles, 16 x installation clips

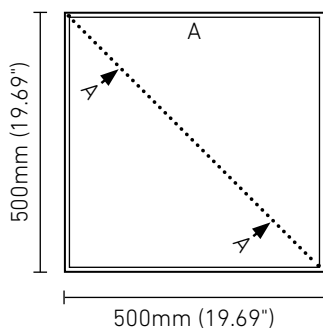

For additional specifications and performance details please visit wovenimage.com **HERE**



DUNE tiles in colours 908 & 349

ACOUSTIC TILE COLLECTION

WAVE



908

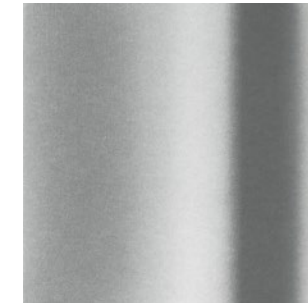

101



447

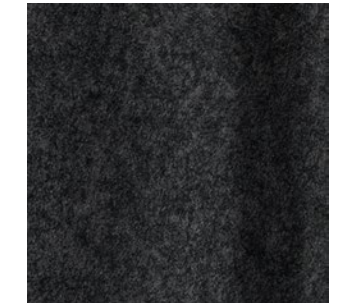

542



487

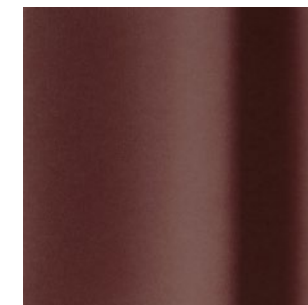

269



349



660

TILE DIMENSIONS

500mm (+/-5mm) x 500mm (+/-5mm) x 62.5mm (+/-5mm)
 19.69" (+/-0.2") x 19.69" (+/-0.2") x 2.46" (+/-0.2")

TILE THICKNESS

4mm (+/-0.5mm) | 0.16" (+/-0.02") - measured 0.39" (10mm) above trimmed edge

SOUND ABSORPTION

AS ISO 354: 2006 (R2016) - direct fix results

α_w 0.50 (MH)

NRC 0.60

SAA 0.58

Class D

BOX COMPONENTS

9 x tiles, 16 x installation clips

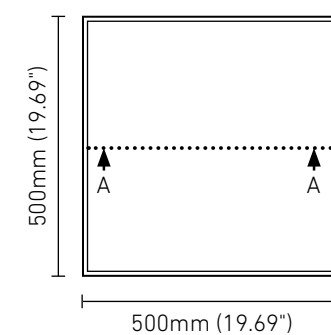

For additional specifications and performance details please visit wovenimage.com **HERE**

ACOUSTIC FABRIC

FOCUS CHAIN



FOCUS CHAIN in colours 300 & 908

ACOUSTIC FABRIC

FOCUS WAVE

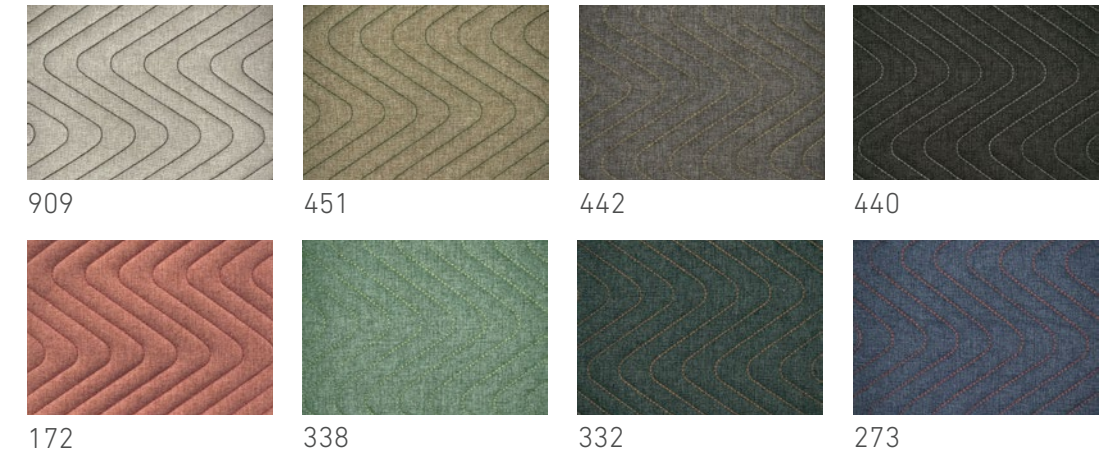

FOCUS WAVE in colour 172

WIDTH	137cm 53.94"	
PATTERN REPEAT	FOCUS CHAIN	Horizontal 19cm (7.48"), Vertical 19.5cm (7.68")
	FOCUS WAVE	Horizontal 2.5cm (0.98"), Vertical 11cm (4.33")
SOUND ABSORPTION	AS ISO 354: 2006 (R2016) - direct fix results	
	α_w	0.20 (H)
	NRC Value	0.30
	SAA	0.29

For additional specifications and performance details please visit wovenimage.com **HERE**

ACOUSTIC COLLECTION

PRINT DESIGNS

Shown here are a small selection of our printed EchoPanel® designs. These can be printed single or double-sided, making them suitable for walls, ceilings and partitions.

Woven Image has a long history of working with global design and manufacturing clients to deliver unique customised prints. Contact us to discuss your project requirements.

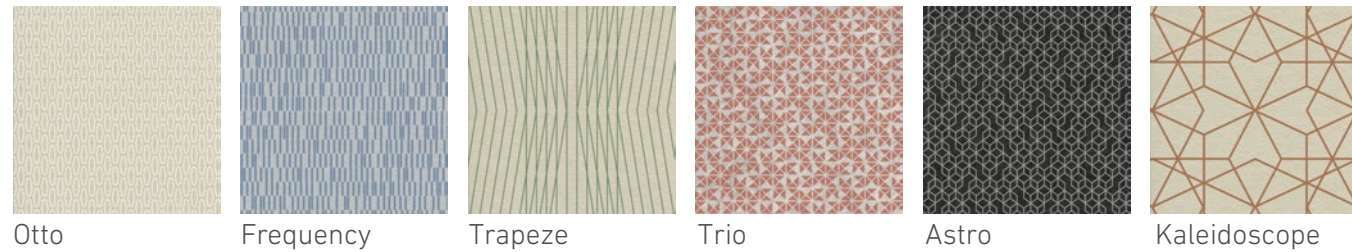

Michael Jolley COLLECTION

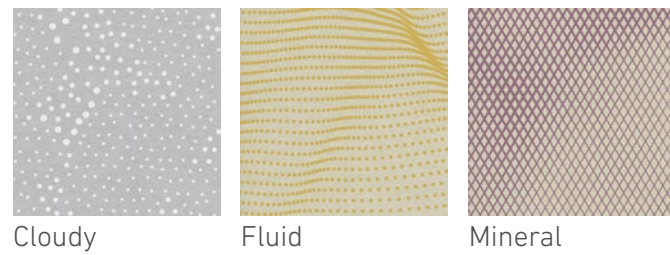

EchoPanel® 12mm KALEIDOSCOPE in colour 580

For additional specifications and performance details please visit wovenimage.com **HERE**



EchoPanel® 12mm TRAPEZE in colour 365



w*i*

WOVEN IMAGE®