THE COLLECTION



wvi
WOVEN IMAGE®

THE COLLECTION

WOVEN IMAGE STORY 02

ECHOPANEL® COLLECTION..... 04

CEILING COLLECTION..... 24

SPACE DIVIDING COLLECTION..... 36

MURA COLLECTION 46

EMBOSSED PANEL COLLECTION..... 50

ACOUSTIC TILE COLLECTION 60

ACOUSTIC FABRIC 70

PRINT DESIGNS..... 72



Cover image: **ION** in colour 550
 This image: **BALANCE 1340** tile in colour 365

Disclaimer Due different screen configurations, images may not represent the true colour. Always confirm your colour choice with your Woven Image Sales Representative.

We recommend you request a sample prior to ordering.

THE COLLECTION

WOVEN IMAGE STORY



MANUFACTURING PROCESS OF ECHOPANEL® & MURA

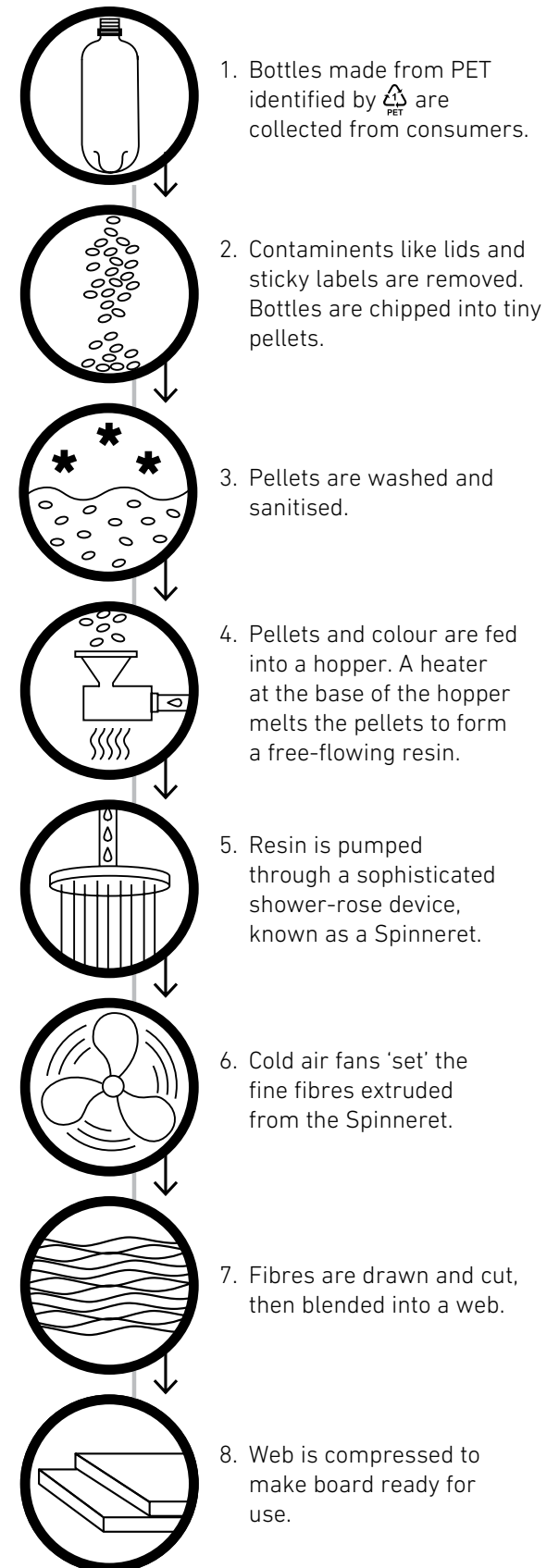

Established in 1987, Woven Image is an international interior finishes company with sustainability and design leadership at its core.

From humble beginnings in Sydney, Woven Image now has offices throughout Australia as well as Singapore, Hong Kong and China, and a network of distributors and stockists across all major markets including Europe and the UK, Asia and the Middle East, and The Americas.

The product portfolio consists of acoustic finishes such as EchoPanel®, suitable for wall, ceiling and space dividing applications in interior spaces including workplace, hospitality, education and healthcare sectors.

OUR ENVIRONMENTAL STORY

The Woven Image portfolio has been designed with dematerialisation, upcycling and lifecycle management front of mind. All base materials in this collection utilise recycled or waste materials and printed designs use non-toxic inks with low VOCs.

Woven Image achieves first-class environmental certifications for its key products, including Global GreenTag™ certification (GreenRate Level A), with the maximum Product Health Declaration™ Platinum Health and an Environmental Product Declaration (EPD). As a result, specifying these products can secure credits under sustainable building tools including Leadership in Energy and Environmental Design (LEED v4.1), WELL™ Building Standard and Green Star. Woven Image is also a long-term supporter of Greenfleet and offsets its carbon emissions through their bio-diverse program.

ECHOPANEL® COLLECTION

- ECHOPANEL® PALETTE 06
- PRECISION CUT DESIGNS 08
 - ECHOPANEL® PALACE 10
 - ECHOPANEL® OHM 12
 - ECHOPANEL® EMPIRE 14
 - ECHOPANEL® LONGITUDE 16
 - ECHOPANEL® LATITUDE 18
 - ECHOPANEL® MERIDIAN 20
 - ECHOPANEL® ALIGN 22

Invented and launched by Woven Image in 2004, EchoPanel® is the original decorative interior panelling solution, with acoustic qualities and eco-innovation at its core. EchoPanel® production uses post-consumer recycled PET bottles to create a superior upcycled product, with a 10-year life expectancy, after which the material is still 100% recyclable. Since 2022, Woven Image have also committed to offset the embodied carbon of EchoPanel® acoustic panels to zero.

EchoPanel® is available in a comprehensive range of neutral, mid-tone and vibrant colours. Due to its unique manufacturing process, the colour remains consistent throughout the depth of the panel.

EchoPanel® is pinnable, durable, lightweight and easy to cut and install, making it ideal for a multitude of wall, ceiling and free-standing commercial interior applications. Available in 12mm (0.47") and 24mm (0.94") thicknesses.



EchoPanel® 12mm In colour 660

ECHOPANEL® PALETTE

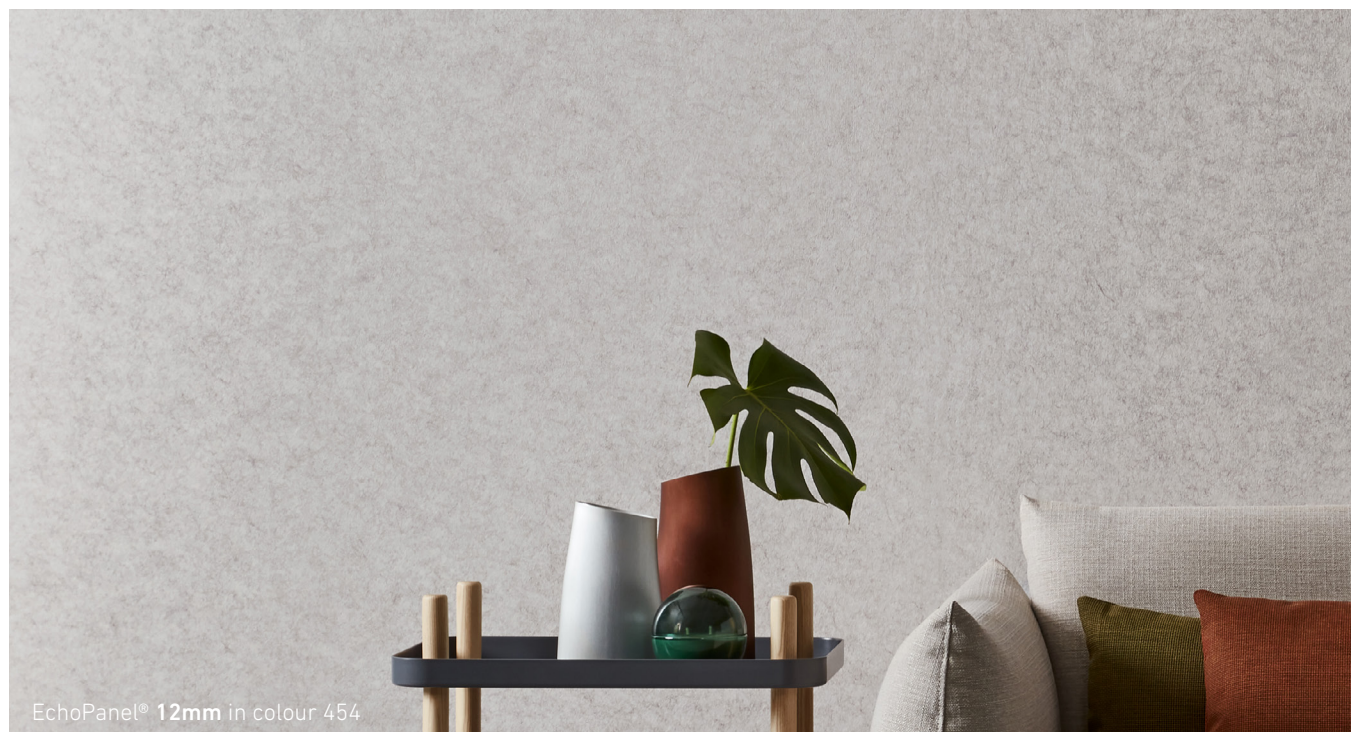

EchoPanel® 12mm in colour 454

PANEL DIMENSIONS 2800mm (+/-10mm) x 1200mm (+/-5mm) | 110.24" (+/-0.39") x 47.24" (+/-0.2")

PANEL THICKNESS
12mm (+/-7%) | 0.47" (+/-7%)
24mm (+/-7%) | 0.94" (+/-7%)

SOUND ABSORPTION AS ISO 354: 2006 (R2016) - direct fix results

12mm (0.47")
 α_w 0.30 (MH)
 NRC 0.45
 SAA 0.43
 Class D

24mm (0.94")
 α_w 0.45 (MH)
 NRC 0.65
 SAA 0.63
 Class D

QUICK REFERENCE GUIDE

PANEL DIMENSIONS
12mm x 2800mm x 1200mm | **0.47"** x 110.24" x 47.24"
24mm x 2800mm x 1200mm | **0.94"** x 110.24" x 47.24"

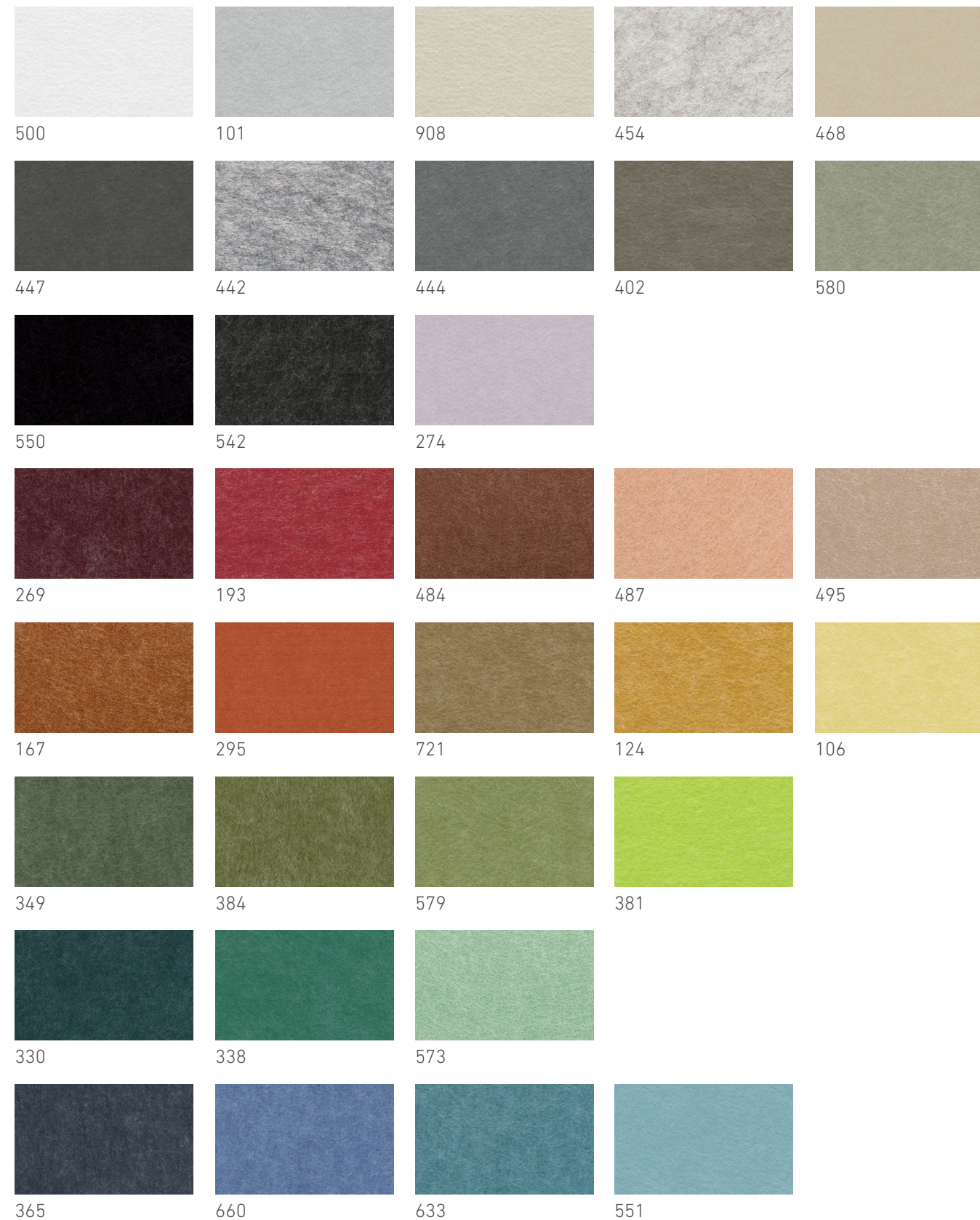
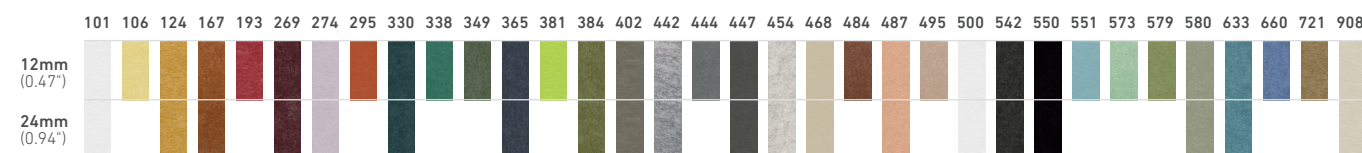

For additional specifications and performance details please visit wovenimage.com **HERE**

ECHOPANEL® COLLECTION

PRECISION CUT
DESIGNS



PRECISION CUT DESIGNS

ECHOPANEL® PALACE



EchoPanel® PALACE in colour 349

COLOURS	Available in 32 EchoPanel® colours - see website for details
PANEL DIMENSIONS	2750mm (+/-2mm) x 1100mm (+/-2mm) 108.27" (+/-0.08") x 43.31" (+/-0.08")
PANEL THICKNESS	12mm (+/-7%) 0.47" (+/-7%) 24mm (+/-7%) 0.94" (+/-7%)

SOUND ABSORPTION	AS ISO 354: 2006 (R2016) - direct fix results	
12mm (0.47")	α_w	0.30 (MH)
	NRC	0.45
	SAA	0.43
	Class	D
24mm (0.94")	α_w	0.45 (MH)
	NRC	0.65
	SAA	0.63
	Class	D

For additional specifications and performance details please visit [wovenimage.com](https://www.wovenimage.com) **HERE**

PRECISION CUT DESIGNS

ECHOPANEL® OHM



EchoPanel® OHM in colour 454

COLOURS	Full EchoPanel® colour range - see page 7
PANEL DIMENSIONS	2750mm (+/-2mm) x 1100mm (+/-2mm) 108.27" (+/-0.08") x 43.31" (+/-0.08")
PANEL THICKNESS	12mm (+/-7%) 0.47" (+/-7%) 24mm (+/-7%) 0.94" (+/-7%)

SOUND ABSORPTION	AS ISO 354: 2006 (R2016) - direct fix results	
12mm (0.47")	α_w	0.30 (MH)
	NRC	0.45
	SAA	0.43
	Class	D
24mm (0.94")	α_w	0.45 (MH)
	NRC	0.65
	SAA	0.63
	Class	D

For additional specifications and performance details please visit wovenimage.com **HERE**

PRECISION CUT DESIGNS

ECHOPANEL® EMPIRE



EchoPanel® EMPIRE in colour 365

COLOURS	Full EchoPanel® colour range - see page 7
PANEL DIMENSIONS	2750mm (+/-2mm) x 1100mm (+/-2mm) 108.27" (+/-0.08") x 43.31" (+/-0.08")
PANEL THICKNESS	12mm (+/-7%) 0.47" (+/-7%) 24mm (+/-7%) 0.94" (+/-7%)

SOUND ABSORPTION	AS ISO 354: 2006 (R2016) - direct fix results	
12mm (0.47")	α_w	0.30 (MH)
	NRC	0.45
	SAA	0.43
	Class	D
24mm (0.94")	α_w	0.45 (MH)
	NRC	0.65
	SAA	0.63
	Class	D

For additional specifications and performance details please visit wovenimage.com **HERE**

PRECISION CUT DESIGNS

ECHOPANEL® LONGITUDE



EchoPanel® LONGITUDE in colour 269

COLOURS	Full EchoPanel® colour range - see page 7
PANEL DIMENSIONS	2750mm (+/-2mm) x 1100mm (+/-2mm) 108.27" (+/-0.08") x 43.31" (+/-0.08")
PANEL THICKNESS	12mm (+/-7%) 0.47" (+/-7%) 24mm (+/-7%) 0.94" (+/-7%)

SOUND ABSORPTION	AS ISO 354: 2006 (R2016) - direct fix results	
12mm (0.47")	α_w	0.30 (MH)
	NRC	0.45
	SAA	0.43
	Class	D
24mm (0.94")	α_w	0.45 (MH)
	NRC	0.65
	SAA	0.63
	Class	D

For additional specifications and performance details please visit wovenimage.com **HERE**

PRECISION CUT DESIGNS

ECHOPANEL® LATITUDE



EchoPanel® LATITUDE in colour 384

COLOURS	Full EchoPanel® colour range - see page 7
PANEL DIMENSIONS	2750mm (+/-2mm) x 1100mm (+/-2mm) 108.27" (+/-0.08") x 43.31" (+/-0.08")
PANEL THICKNESS	12mm (+/-7%) 0.47" (+/-7%) 24mm (+/-7%) 0.94" (+/-7%)

SOUND ABSORPTION	AS ISO 354: 2006 (R2016) - direct fix results	
12mm (0.47")	α_w	0.30 (MH)
	NRC	0.45
	SAA	0.43
	Class	D
24mm (0.94")	α_w	0.45 (MH)
	NRC	0.65
	SAA	0.63
	Class	D

For additional specifications and performance details please visit wovenimage.com **HERE**



PRECISION CUT DESIGNS

ECHOPANEL® MERIDIAN

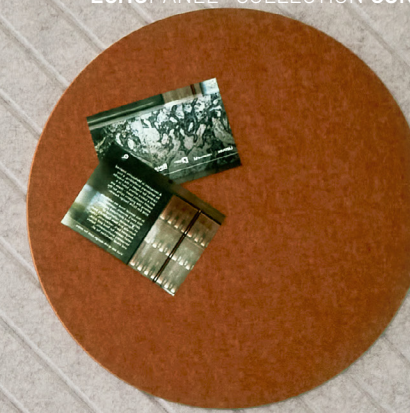

EchoPanel® MERIDIAN in colours 580 & 454

COLOURS	Full EchoPanel® colour range - see page 7
PANEL DIMENSIONS	2750mm (+/-2mm) x 1100mm (+/-2mm) 108.27" (+/-0.08") x 43.31" (+/-0.08")
PANEL THICKNESS	12mm (+/-7%) 0.47" (+/-7%) 24mm (+/-7%) 0.94" (+/-7%)

SOUND ABSORPTION	AS ISO 354: 2006 (R2016) - direct fix results	
12mm (0.47")	α_w	0.30 (MH)
	NRC	0.45
	SAA	0.43
	Class	D
24mm (0.94")	α_w	0.45 (MH)
	NRC	0.65
	SAA	0.63
	Class	D

For additional specifications and performance details please visit wovenimage.com **HERE**

PRECISION CUT DESIGNS

ECHOPANEL® ALIGN



EchoPanel® ALIGN in colour 454

COLOURS	Full EchoPanel® colour range - see page 7
PANEL DIMENSIONS	2750mm (+/-2mm) x 1180mm (+/-2mm) 108.27" (+/-0.08") x 46.46" (+/-0.08")
PANEL THICKNESS	12mm (+/-7%) 0.47" (+/-7%) 24mm (+/-7%) 0.94" (+/-7%)

SOUND ABSORPTION	AS ISO 354: 2006 (R2016) - direct fix results	
12mm (0.47")	α_w	0,30 (MH)
	NRC	0,45
	SAA	0,43
	Class	D
24mm (0.94")	α_w	0,45 (MH)
	NRC	0,65
	SAA	0,63
	Class	D

For additional specifications and performance details please visit wovenimage.com **HERE**

CEILING COLLECTION

Woven Image offer design-driven and high-performance acoustic ceiling solutions, to control reverberated noise in commercial interior spaces.

EchoPanel® Array is an acoustic ceiling baffle solution utilising 12mm (0.47") and 24mm (0.94") EchoPanel®, with streamlined hardware engineered for easy installation, and scalable for both small and large applications. Choose from beautifully crafted baffles in the extensive EchoPanel® colour palette, or work with us to create your own unique designs.

Fuji is a range of decorative 3D formed ceiling tiles, offering superb acoustic absorption. Fuji tiles can be installed with or without the Array ceiling hardware, with options to direct-fix or suspend from the ceiling and integrate a variety of lighting options.

EchoPanel® Element comprises of a series of cut EchoPanel® blades which slot together to form a square lattice. Element can be attached to existing ceiling grids, or directly fixed or suspended from the ceiling.

Woven Image's inhouse Commercial Service team provide industry expertise, advice and CAD technical plans and drawings, to ensure ceiling projects are delivered to the highest standards.

ECHOPANEL® ARRAY	26
FUJI	30
ECHOPANEL® ELEMENT	34



FUJI ROKU in colour 420 with onyx/gold barrel kits



CEILING COLLECTION

ECHOPANEL® ARRAY

12mm & 24mm

EchoPanel® Array baffle and ceiling hardware dimensions will vary depending on project requirements. Exact quantities, measurements and drawings will be provided upon project specification.

Standard baffle designs are 2780mm in length and vary in depth, please see below:

BEAM



2780mm length x 200mm depth (+/-5mm)



2780mm length x 300mm depth (+/-5mm)

WEDGE

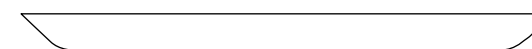

2780mm length x 200mm depth (+/-5mm)

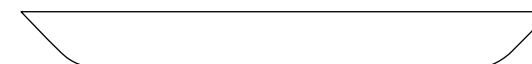

2780mm length x 300mm depth (+/-5mm)

TAPER

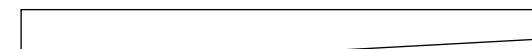

2780mm length x 300mm depth (+/-5mm)

CATHEDRAL



2780mm length x 300mm depth (+/-5mm)

TURRET



2780mm length x 300mm depth (+/-5mm)

VALLEY

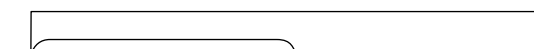

2780mm length x 300mm depth (+/-5mm)

VIADUCT



2780mm length x 300mm depth (+/-5mm)

WAVE



2780mm length x 267mm depth (+/-5mm)

FLOW

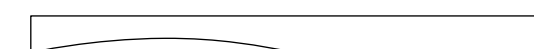

2780mm length x 300mm depth (+/-5mm)

For additional specifications and performance details please visit wovenimage.com **HERE**

CEILING COLLECTION

ECHOPANEL® ARRAY

12mm & 24mm

ARRAY FLOW 24mm in colours 633, 349 & 908

COLOURS

Full EchoPanel® colour range - see page 7

DIMENSIONS

For standard baffle styles & dimensions - see page 27

SOUND ABSORPTION

12mm (+/-7%) | 0.47" (+/-7%) - direct fix results

AS ISO 354: 2006 (R2016)

AS ISO 11654: 2002 (2016)

ASTM C423 - 17

α_w 0.65 (H)

NRC 0.70

SAA 0.68

Class C

SOUND ABSORPTION

24mm (+/-7%) | 0.94" (+/-7%) - direct fix results

AS ISO 354: 2006 (R2016)

AS ISO 11654: 2002 (2016)

ASTM C423 - 17

α_w 0.75 (MH)

NRC 0.85

SAA 0.83

Class C

For additional specifications and performance details please visit wovenimage.com **HERE**



CEILING COLLECTION

FUJI

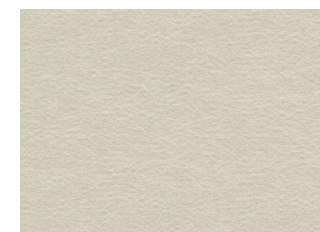

908

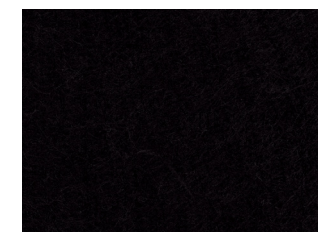

550



299

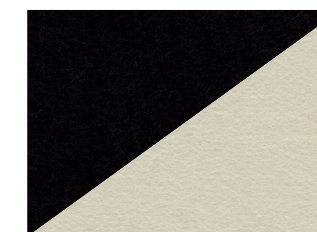

420



ARRAY RAILS in colours black & white



BARREL KITS in colours onyx, off-white & onyx/gold

COLOURS

Stocked in 4 standard colours – full Mura colour range available on request, see page 48. Barrel kits allow Fuji tiles to be directly fixed to the ceiling or to the Array ceiling rail.

DIMENSIONS

FUJI KU 840mm (+/-3mm) x 840mm (+/-3mm) x 132mm (+/-3mm)
33.07" (+/-0.12") x 33.07" (+/-0.12") x 5.2" (+/-0.12")

FUJI HACHI 1740mm (+/-3mm) x 840mm (+/-3mm) x 132mm (+/-3mm)
68.5" (+/-0.12") x 33.07" (+/-0.12") x 5.2" (+/-0.12")

THICKNESS

4.6mm (+/-2mm) | 0.18" (+/-0.08")

SOUND ABSORPTION

AS ISO 11654: 2002 (2016) | AS ISO 354: 2006 (R2016) | ASTM C423 - 17, with perimeter

FUJI KU	α_w	0.80
	NRC	0.75
	SAA	0.74

FUJI HACHI	α_w	0.85
	NRC	0.80
	SAA	0.76

For additional specifications and performance details please visit wovenimage.com **HERE**



CEILING COLLECTION

FUJI



FUJI ROKU & FUJI JUNI in colour 908 with off-white barrel kits

COLOURS Stocked in 4 standard colours – full Mura colour range available on request, see page 48. Barrel kits allow Fuji tiles to be directly fixed to the ceiling or to the Array ceiling rail.

DIMENSIONS

FUJI ROKU 560mm (+/-3mm) x 560mm (+/-3mm) x 90mm (+/-3mm)
22.05" (+/-0.12") x 22.05" (+/-0.12") x 3.54" (+/-0.12")

FUJI JUNI 560mm (+/-3mm) x 1160mm (+/-3mm) x 90mm (+/-3mm)
22.05" (+/-0.12") x 45.67" (+/-0.12") x 3.54" (+/-0.12")

THICKNESS 4.6mm (+/-2mm) | 0.18" (+/-0.08")

SOUND ABSORPTION AS ISO 11654: 2002 (2016) | AS ISO 354: 2006 (R2016) | ASTM C423 - 17, with perimeter

FUJI ROKU	α_w	0.75
	NRC	0.70
	SAA	0.72
FUJI JUNI	α_w	0.80
	NRC	0.80
	SAA	0.76

For additional specifications and performance details please visit wovenimage.com **HERE**



CEILING COLLECTION

ECHOPANEL® ELEMENT

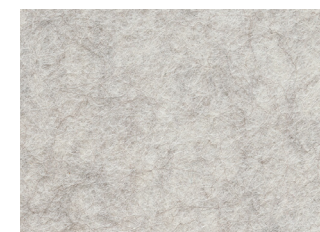

454



442



542



EchoPanel® ELEMENT in colour 454 suspended

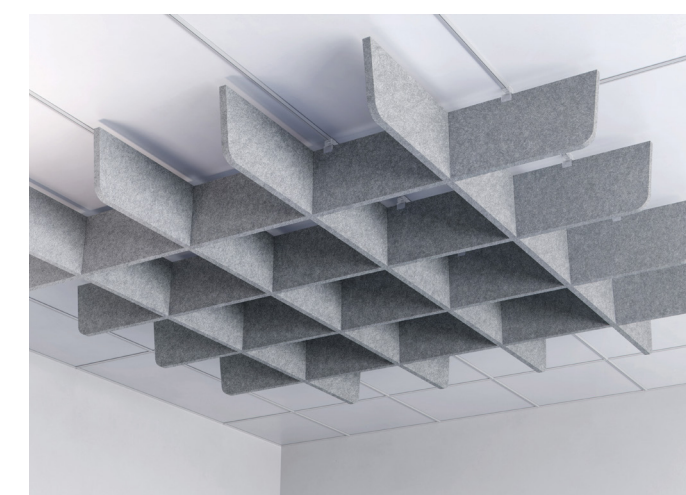

EchoPanel® ELEMENT in colour 442 clipped to ceiling grid

ASSEMBLED DIMENSIONS 2350mm (+/-2mm) x 2350mm (+/-2mm) x 215mm (+/-2mm)
92.52" (+/-0.08") x 92.52" (+/-0.08") x 8.46" (+/-0.08")

BLADE THICKNESS 24mm (+/-7%) | 0.94" (+/-7%)

SOUND ABSORPTION AS ISO 11654: 2002 (2016)
ASTM C423 - 17

α _w	0.40
NRC	0.35
SAA	0.36
Class	D

BOX COMPONENTS 8 x EchoPanel® blades
16 x ceiling clips
Suspension kit sold separately

For additional specifications and performance details please visit wovenimage.com **HERE**

SPACE DIVIDING COLLECTION

Our range of EchoPanel® space dividing systems includes hanging pendants and free-standing room dividers.

These products allow open plan spaces, typical of modern workplace and hospitality environments, to be partitioned with ease and flexibility whilst reducing reverberated noise to improve both comfort and productivity.

HANGING PENDENTS.....	38
PALING.....	42
PLATOON.....	44



EchoPanel® 12mm SUMMIT pendant in colours 442 & 365

SPACE DIVIDING COLLECTION

HANGING PENDENTS

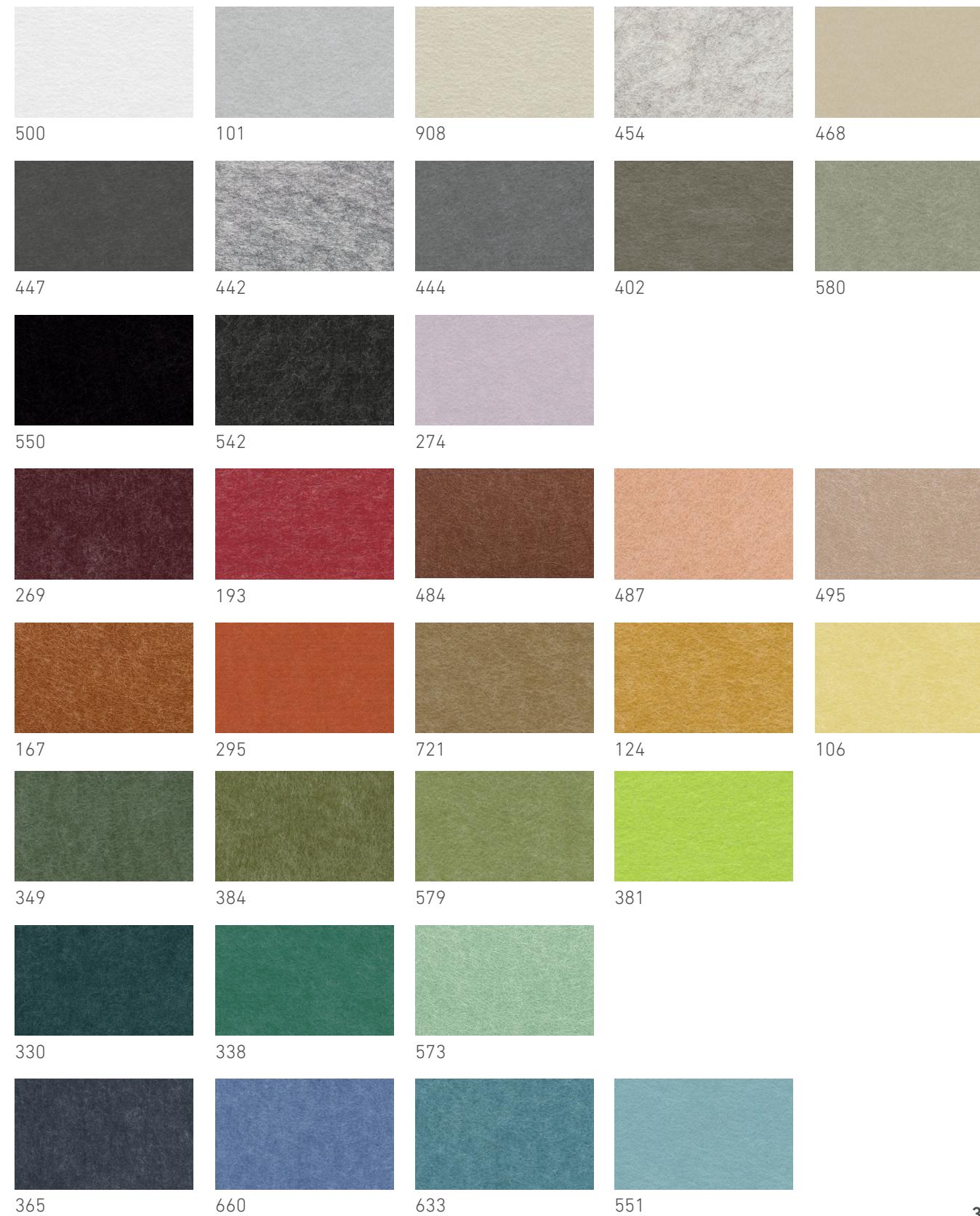

SPACE DIVIDING COLLECTION

HANGING PENDENTS



COLOURS	Full EchoPanel® 12mm (0.47") colour range - see page 39
PENDENT DESIGNS	5 styles
PANEL DIMENSIONS	12mm (+/-7%) 0.47" (+/-7%) 2400mm (+/-2mm) x 1200mm (+/-10mm) 94.49" (+/-0.08") x 47.24" (+/-0.39")
SOUND ABSORPTION	See EchoPanel® 12mm (0.47") on page 6 for details
BOX COMPONENTS	1 x cut EchoPanel® 12mm (0.47") 1 x 12mm hanging pendent component kit

PENDENT DESIGNS

12mm | 0.47"

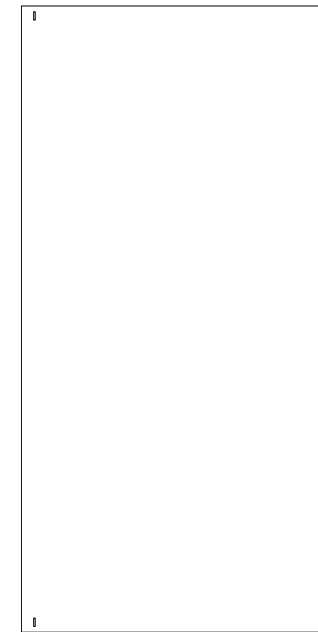

TANDEM 12mm | 0.47"

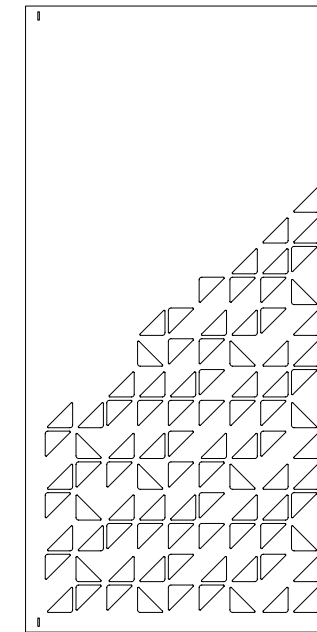

SUMMIT 12mm | 0.47"

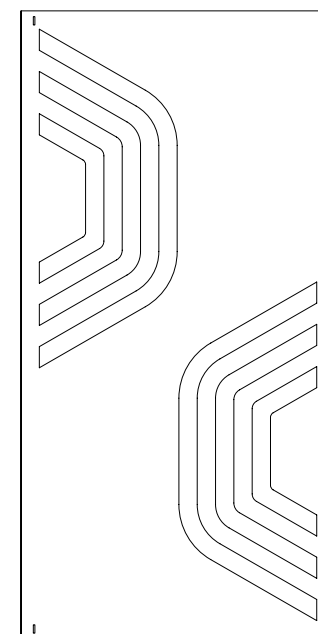

DOT 12mm | 0.47"

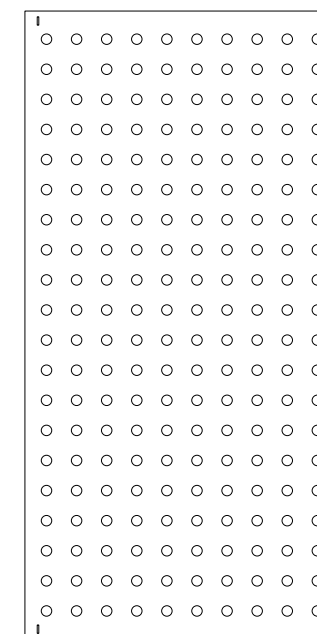

SPLAY 12mm | 0.47"

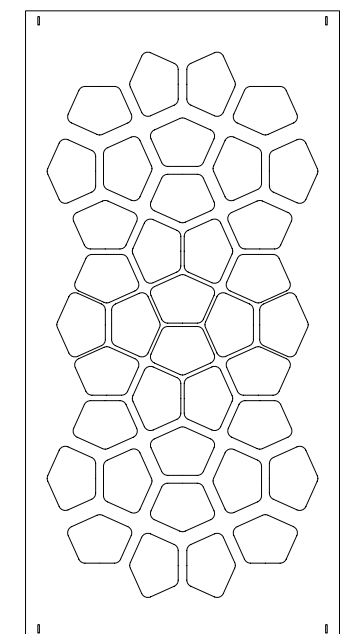

For additional specifications and performance details please visit wovenimage.com **HERE**

SPACE DIVIDING COLLECTION

PALING

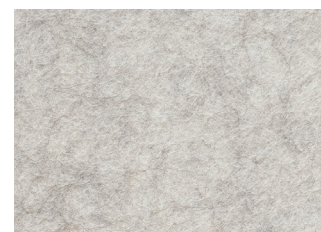

454



442



542

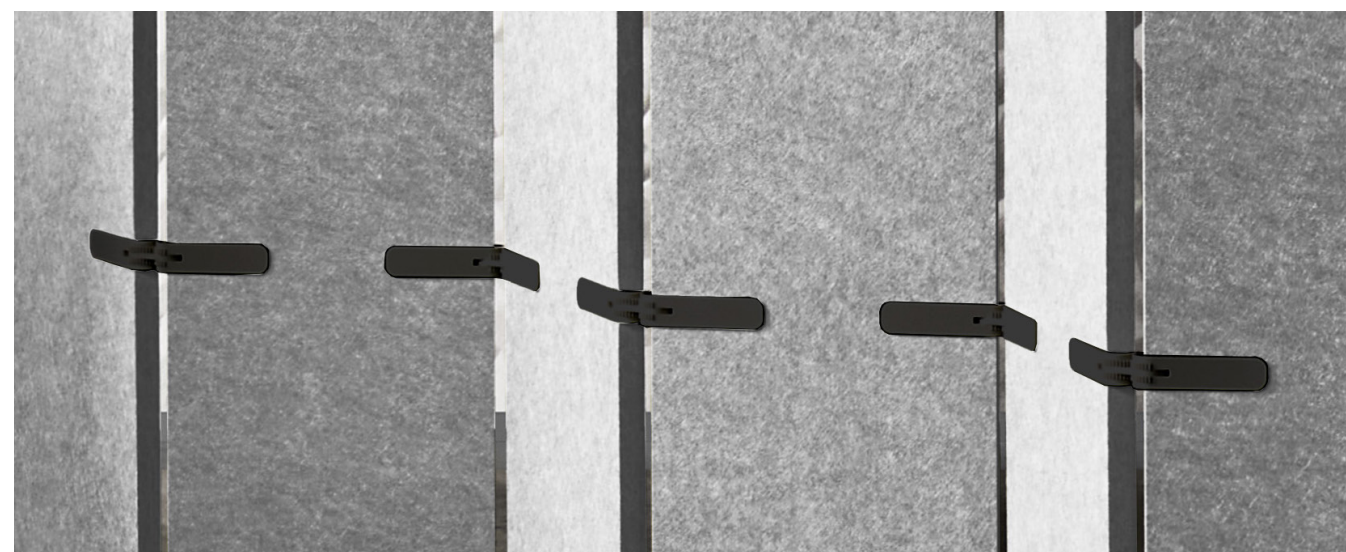

EchoPanel® PALING in colour 442 with charcoal pivot joiners

PRODUCT TYPE	Free-standing system
PANEL DIMENSIONS	PALING A (end panel) & B (middle panel) 285mm (+/-2mm) x 1750mm (+/-2mm) 11.22" (+/-0.08") x 68.9" (+/-0.08")
PANEL THICKNESS	24mm (+/-7%) 0.94" (+/-7%)
PIVOT JOINER COLOURS	Cream and charcoal - to be specified in order
SOUND ABSORPTION	See EchoPanel® 24mm (0.94") on page 6 for details

For additional specifications and performance details please visit wovenimage.com **HERE**

SPACE DIVIDING COLLECTION

PLATOON



PLATOON in colours 442 & 542 with charcoal joiners

PRODUCT TYPE	Free-standing system
FULL PRODUCT DIMENSIONS	1750mm (+/-2mm) x 3500mm (+/-2mm) 68.9" (+/-0.08") x 137.8" (+/-0.08")
PANEL THICKNESS	24mm (+/-7%) 0.94" (+/-7%)
JOINER COLOURS	Cream and charcoal - to be specified in order
SOUND ABSORPTION	See EchoPanel® 24mm (0.94") on page 6 for details
BOX COMPONENTS	6 x PLATOON panels 10 x pivot joiners

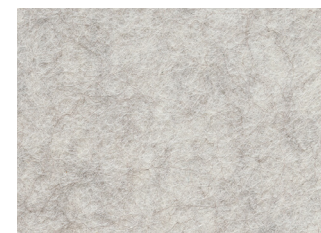

454

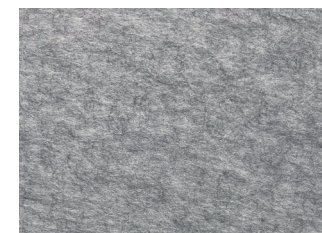

442



542

For additional specifications and performance details please visit wovenimage.com **HERE**

MURA COLLECTION

Mura is an innovative and versatile, 1.9mm (0.075") thick, surface finish that is highly cost effective, easy to install and boasts an on-trend colour palette. The face side has been designed to create a smooth clean look, whilst the back has been engineered with a forgiving texture that can be adhered to a variety of surfaces including walls, workstation screens and operable walls.

Made from 60% recycled PET with low VOCs, Mura has the same first-rate environmental certifications as EchoPanel®.



MURA PALETTE 48



Wall: MURA in colour 454
Desk screen: MURA in colour 551

MURA COLLECTION

MURA PALETTE

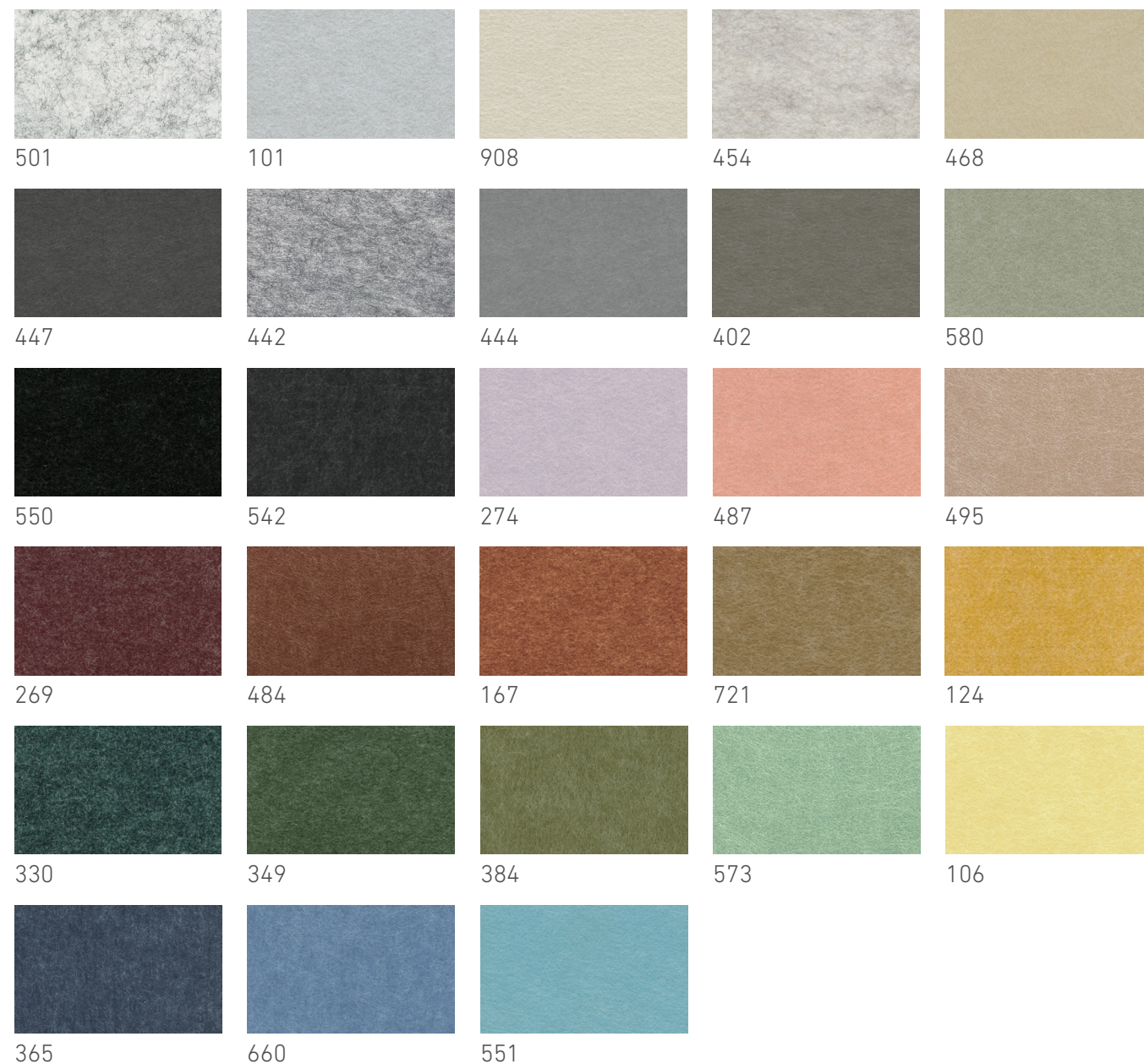

ROLL DIMENSIONS 6m, 25m or 105m roll | 236", 984" or 4134" roll

WIDTH 1210mm (+/-5mm) | 47.64" (+/-0.2")

THICKNESS **1.9mm** (+/-0.25mm) | 0.07" (+/-0.01")

SOUND ABSORPTION AS ISO 354: 2006 (R2016) - direct fix results

αw	0.10 (H)
NRC Value	0.10
SAA	0.08



For additional specifications and performance details please visit wovenimage.com

EMBOSSSED PANEL COLLECTION

The embossed acoustic panel collection represents the latest innovation from Woven Image. Made using recycled plastic, this design-led collection embraces the trend towards tactile surfaces and three-dimensional textures, interweaving cutting-edge design with sustainability and commercial performance.

Available in four unique designs; Zen, Ion, Gem and Pico, which have been specially designed to provide a floor-to-ceiling acoustic solution for commercial office interiors and pattern matches for continuous wall and double-height installations.

The collection has won numerous international design awards including; The Designer Award for Innovation in Material Product Design, the Dezeen Award for Workplace Design, the FX Design Award for Best Surface, the Architizer Award for A+ Products and an INDE Award.

The uniqueness of the design was observed instantly by the Dezeen Awards judges who said that "in this instance, there was an attempt to define the space in sculptural terms and also give the product tactility". The Dezeen Awards received more than 4,300 entries, from 85 countries across 5 continents.

ZEN 52

ION 54

GEM 56

PICO 58



ZEN in colour 365



WINNER 2020



EMBOSSED PANEL COLLECTION

ZEN



PANEL DIMENSIONS 2800mm (+/-3mm) x 1130mm (+/-3mm) | 110.24" (+/-0.12") x 44.49" (+/-0.12")

PANEL THICKNESS 9mm (+/-7%) | 0.35" (+/-7%)

SOUND ABSORPTION AS ISO 354: 2006 (R2016) - direct fix results

α_w 0.20 (H)
 NRC 0.30
 SAA 0.28
 Class E

For additional specifications and performance details please visit wovenimage.com **HERE**

EMBOSSED PANEL COLLECTION

ION



PANEL DIMENSIONS 2800mm (+/-3mm) x 1130mm (+/-3mm) | 110.24" (+/-0.12") x 44.49" (+/-0.12")

PANEL THICKNESS 9mm (+/-7%) | 0.35" (+/-7%)

SOUND ABSORPTION AS ISO 354: 2006 (R2016) - direct fix results

αw	0.20 (H)
NRC	0.30
SAA	0.28
Class	E

For additional specifications and performance details please visit wovenimage.com **HERE**



EMBOSSED PANEL COLLECTION

GEM

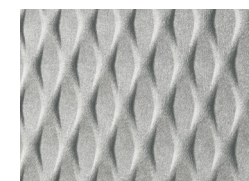

101

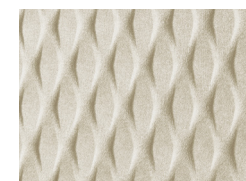

908

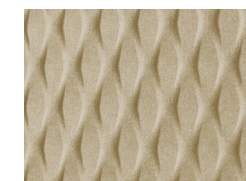

468

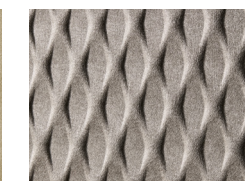

402

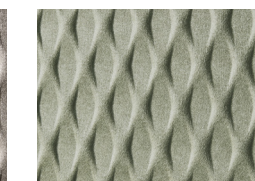

580

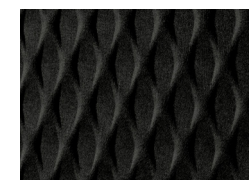

550

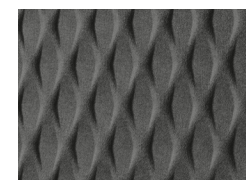

447

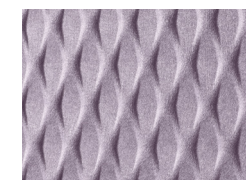

274

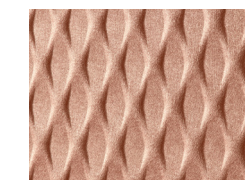

487



495



484

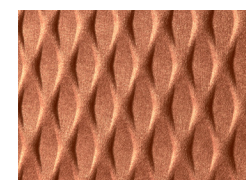

167

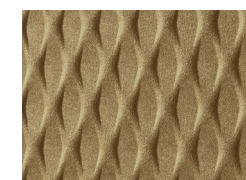

721

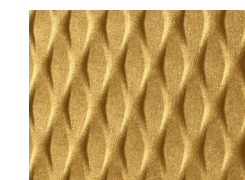

124

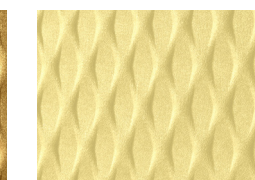

106

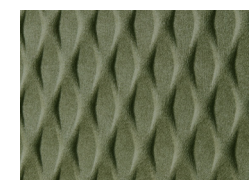

384

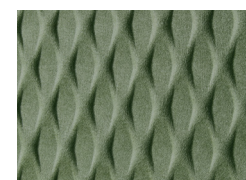

349

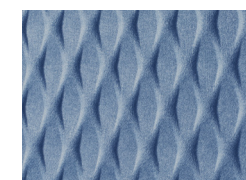

660

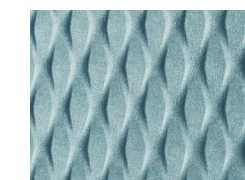

551

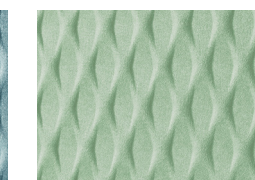

573

PANEL DIMENSIONS 2800mm (+/-3mm) x 1130mm (+/-3mm) | 110.24" (+/-0.12") x 44.49" (+/-0.12")

PANEL THICKNESS 9mm (+/-7%) | 0.35" (+/-7%)

SOUND ABSORPTION AS ISO 354: 2006 (R2016) - direct fix results

α_w 0.20 (H)

NRC 0.30

SAA 0.28

Class E

For additional specifications and performance details please visit wovenimage.com **HERE**

EMBOSSSED PANEL COLLECTION

PICO



PANEL DIMENSIONS 2800mm (+/-3mm) x 1130mm (+/-3mm) | 110.24" (+/-0.12") x 44.49" (+/-0.12")

PANEL THICKNESS 9mm (+/-7%) | 0.35" (+/-7%)

SOUND ABSORPTION AS ISO 354: 2006 (R2016) - direct fix results

α_w	0.20 (H)
NRC	0.30
SAA	0.28
Class	E

For additional specifications and performance details please visit wovenimage.com **HERE**



ACOUSTIC TILE COLLECTION

BALANCE	62
ASCENT	64
DUNE	66
WAVE	68

Whether your interiors project requires large scale coverage or to create smaller design features, this range provides an endless stream of design configurations that provide great aesthetics whilst controlling reverberated noise in;

- Collaborative workspaces and meeting rooms
- Classrooms and music rooms
- Cafés and restaurants
- Lobbies and public spaces

They are lightweight, easy to install, and pattern match without the need for trimming.

Tiles in this collection are made from EchoPanel® or Mura, which achieve first-rate environmental certifications.





ACOUSTIC TILE COLLECTION

BALANCE

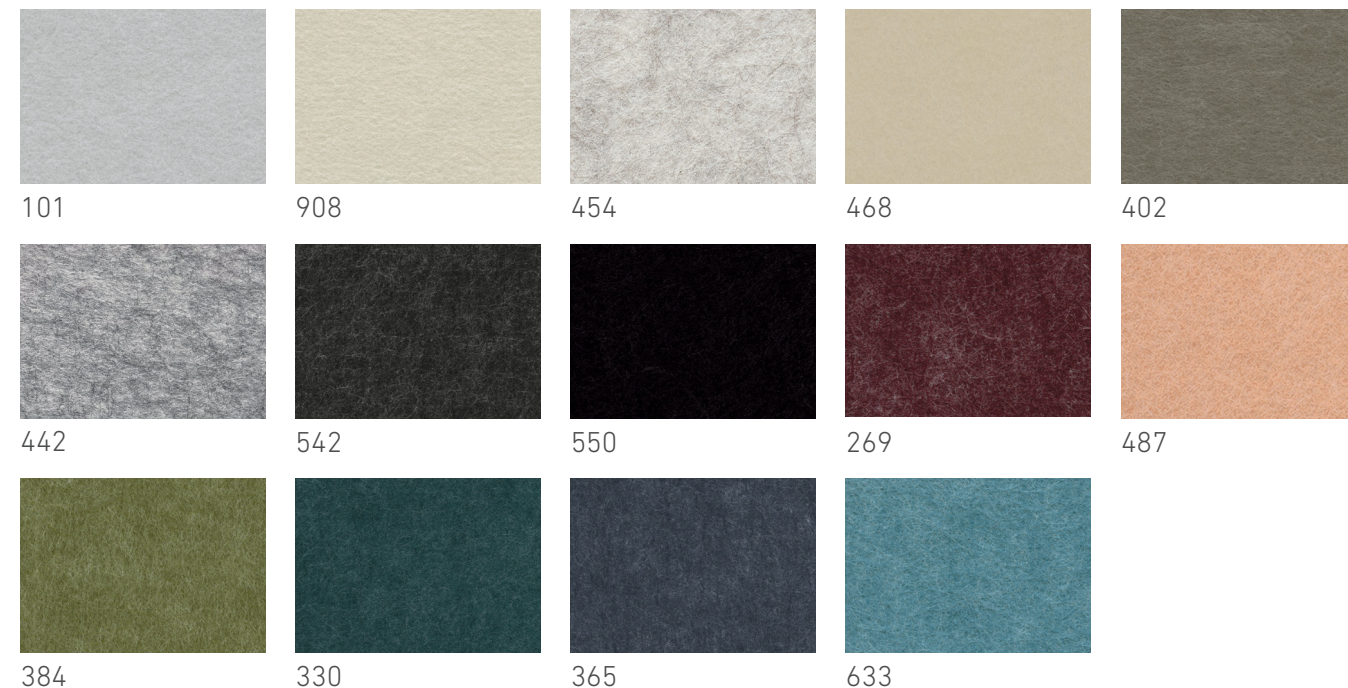

PRODUCT NAME	BALANCE 670 BALANCE 1340
TILE THICKNESS	12mm (+/-7%) 0.47" (+/-7%)
SOUND ABSORPTION	AS ISO 354: 2006 (R2016) - direct fix results αw 0.45 (MH) NRC 0.65 SAA 0.63 Class D
BOX COMPONENTS	BALANCE 670 - 12 x tiles BALANCE 1340 - 6 x tiles

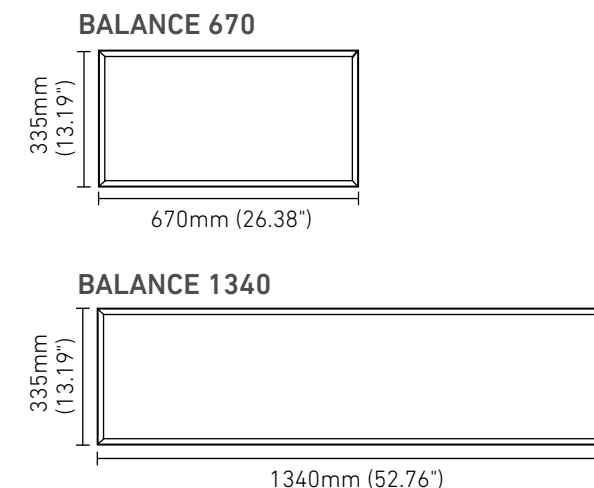

For additional specifications and performance details please visit wovenimage.com **HERE**



ACOUSTIC TILE COLLECTION

ASCENT

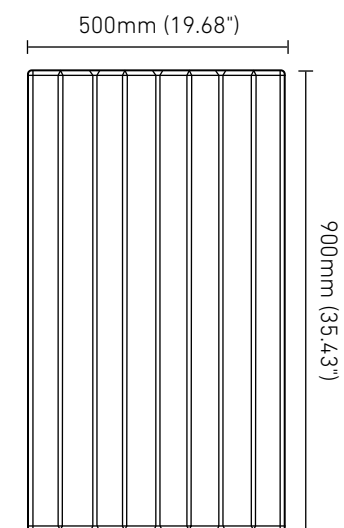
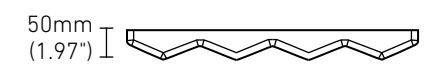
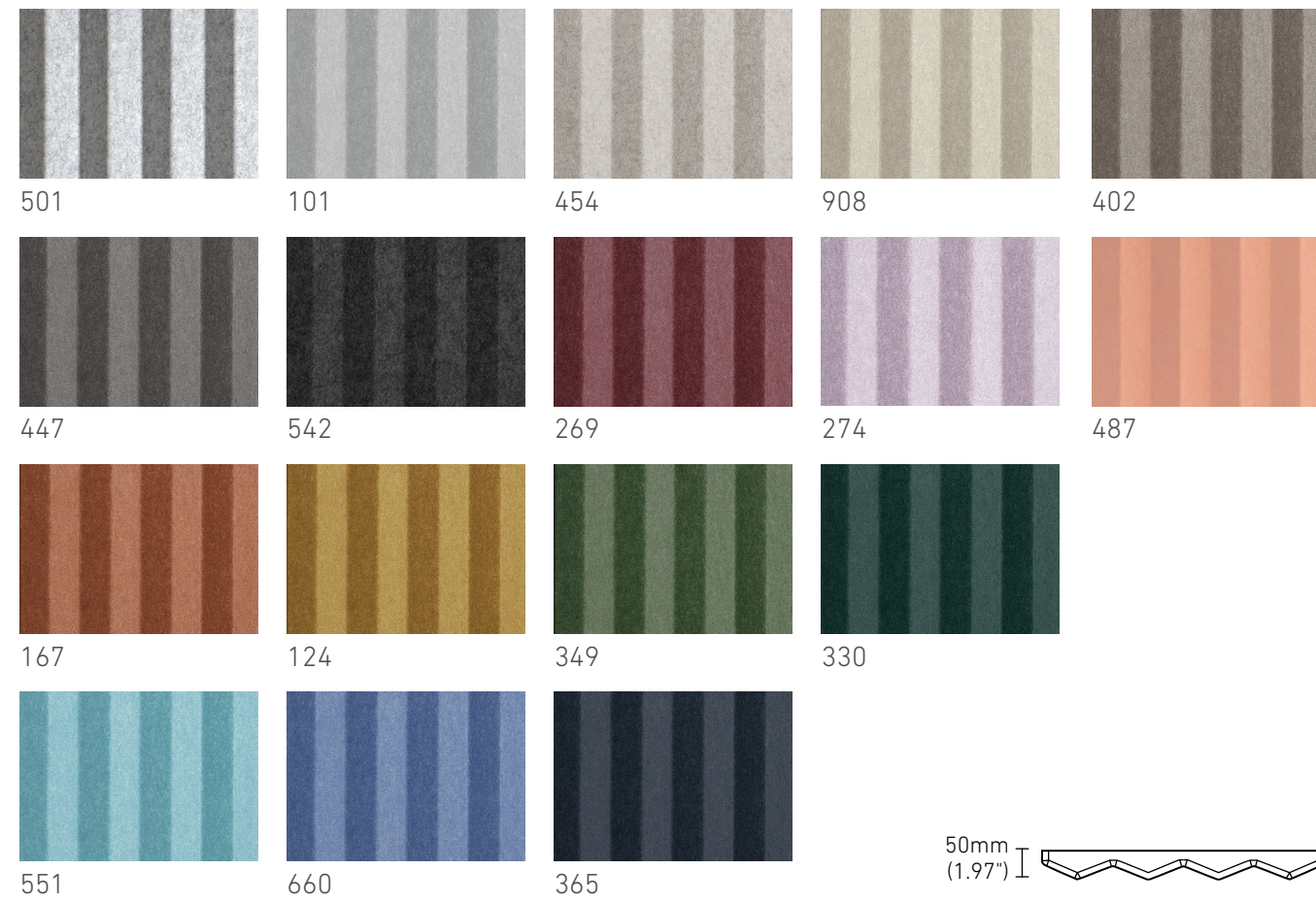
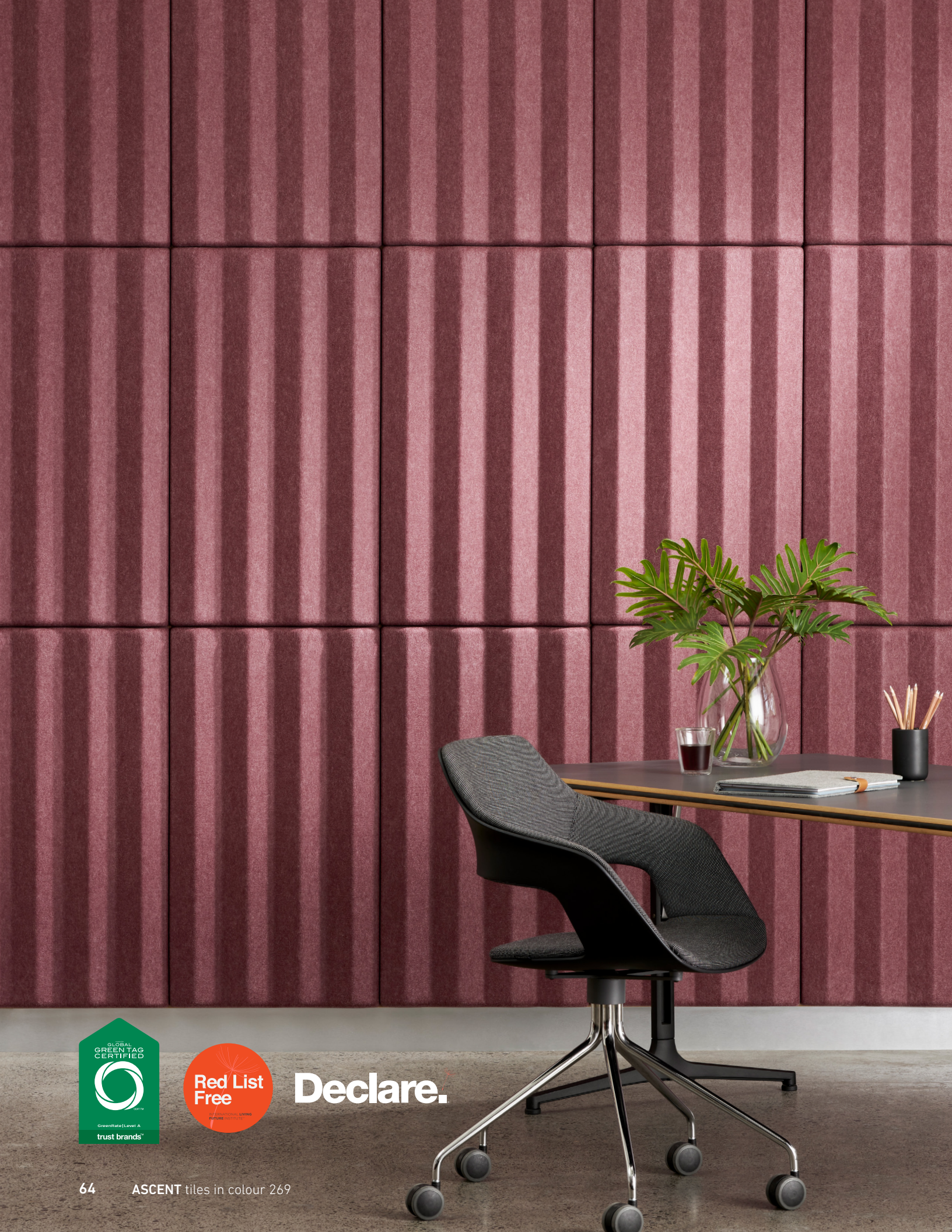

TILE DIMENSIONS 500mm (+/-5mm) x 900mm (+/-5mm) x 50mm (+/-5mm)
19.68" (+/-0.2") x 35.43" (+/-0.2") x 1.97" (+/-0.2")

TILE THICKNESS 4mm (+/-0.5mm) | 0.16" (+/-0.02")
measured 10mm (0.39") above trimmed edge

SOUND ABSORPTION AS ISO 354: 2006 (R2016) - direct fix results
αw 0.60 (MH)
NRC 0.70
SAA 0.66
Class C

BOX COMPONENTS 6 x tiles, 16 x installation clips

For additional specifications and performance details please visit wovenimage.com **HERE**



Declare.

ACOUSTIC TILE COLLECTION

DUNE

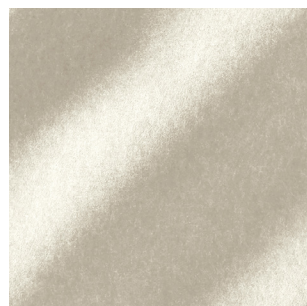

908

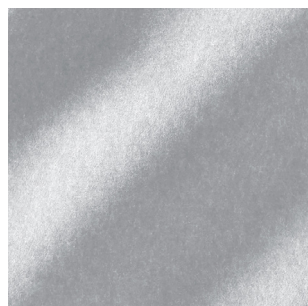

101

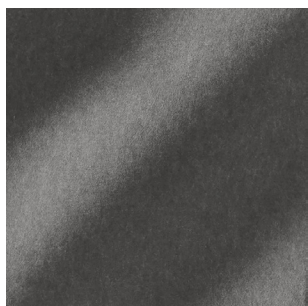

447

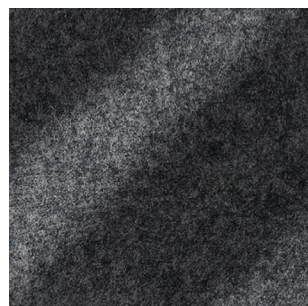

542

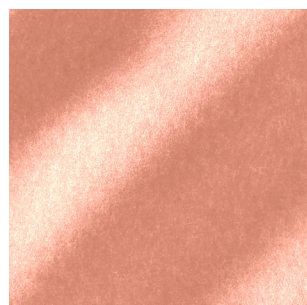

487

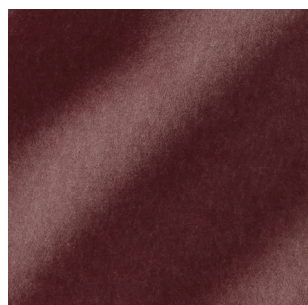

269



349



660

TILE DIMENSIONS

500mm (+/-5mm) x 500mm (+/-5mm) x 50mm (+/-5mm)
19.69" (+/-0.2") x 19.69" (+/-0.2") x 1.97" (+/-0.2")

TILE THICKNESS

4mm (+/-0.5mm) | 0.16" (+/-0.02") - measured 0.39" (10mm) above trimmed edge

SOUND ABSORPTION

AS ISO 354: 2006 (R2016) - direct fix results

α_w 0.50 (MH)
NRC 0.60
SAA 0.58
Class D

BOX COMPONENTS

9 x tiles, 16 x installation clips

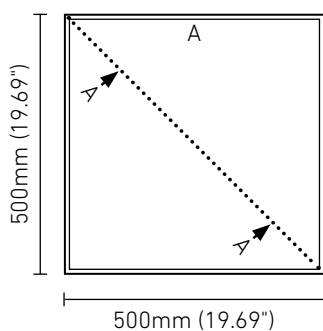

For additional specifications and performance details please visit wovenimage.com **HERE**



ACOUSTIC TILE COLLECTION

WAVE



908



101

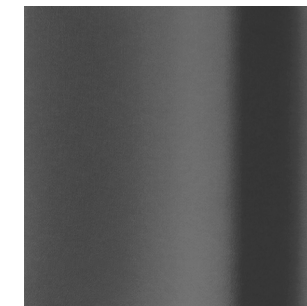

447



542

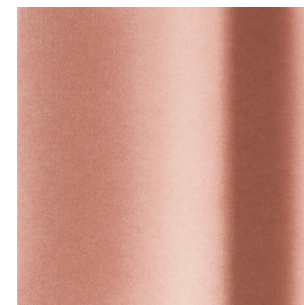

487

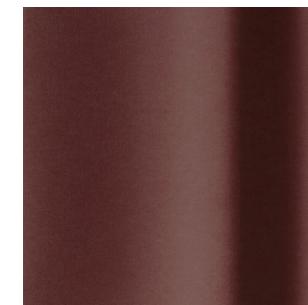

269



349



660

TILE DIMENSIONS

500mm (+/-5mm) x 500mm (+/-5mm) x 62.5mm (+/-5mm)
19.69" (+/-0.2") x 19.69" (+/-0.2") x 2.46" (+/-0.2")

TILE THICKNESS

4mm (+/-0.5mm) | 0.16" (+/-0.02") - measured 0.39" (10mm) above trimmed edge

SOUND ABSORPTION

AS ISO 354: 2006 (R2016) - direct fix results

α_w 0.50 (MH)

NRC 0.60

SAA 0.58

Class D

BOX COMPONENTS

9 x tiles, 16 x installation clips

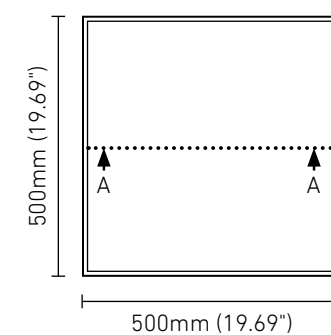

For additional specifications and performance details please visit wovenimage.com **HERE**

ACOUSTIC FABRIC

FOCUS CHAIN



FOCUS CHAIN in colours 300 & 908

ACOUSTIC FABRIC

FOCUS WAVE

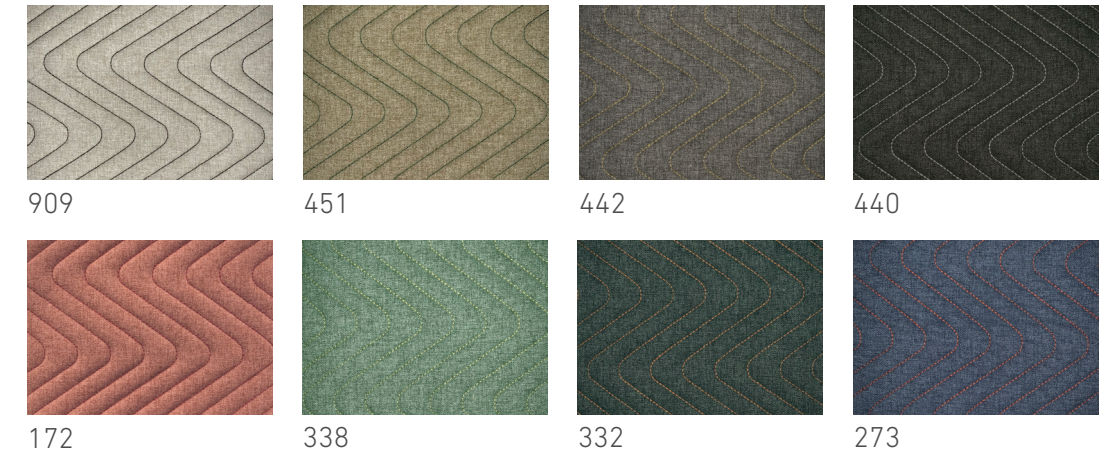

FOCUS WAVE in colour 172

WIDTH	137cm 53.94"	
PATTERN REPEAT	FOCUS CHAIN	Horizontal 19cm (7.48"), Vertical 19.5cm (7.68")
	FOCUS WAVE	Horizontal 2.5cm (0.98"), Vertical 11cm (4.33")
SOUND ABSORPTION	AS ISO 354: 2006 (R2016) - direct fix results	
	α_w	0.20 (H)
	NRC Value	0.30
	SAA	0.29

For additional specifications and performance details please visit wovenimage.com **HERE**

THE COLLECTION

PRINT DESIGNS

Shown here are a small selection of our printed EchoPanel® designs. These can be printed single or double-sided, making them suitable for walls, ceilings and partitions.

Woven Image has a long history of working with global design and manufacturing clients to deliver unique customised prints. Contact us to discuss your project requirements.

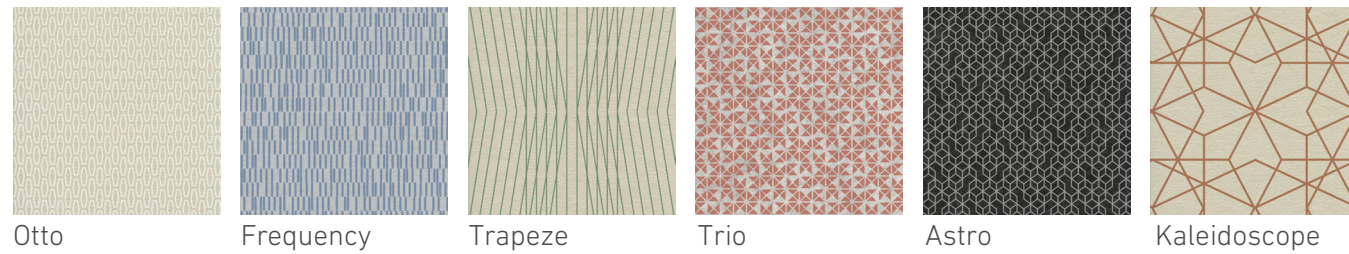

Otto Frequency Trapeze Trio Astro Kaleidoscope



